

Received: 25 August 2024 • Accepted: 7 April 2025 • Published: 24 September 2025

Topic editor: Marie-Béatrice Forel • Desk editor: Kristiaan Hoedemakers

Monograph

urn:lsid:zoobank.org:pub:74A6C5AD-7328-444C-9478-36F290657B6E

Late Permian nautiloids from Julfa (NW Iran)

Dieter KORN^{1,*} & Abbas GHADERI^{2,*}

¹Museum für Naturkunde, Leibniz Institut for Research on Evolution and Biodiversity,
Invalidenstraße 43, 10115 Berlin, Germany.

²Department of Geology, Faculty of Science, Ferdowsi University of Mashhad, Azadi Square,
9177948974 Mashhad, Iran.

*Corresponding authors: dieter.korn@mfn.berlin, aghaderi@um.ac.ir

Abstract. The Late Permian Julfa and Ali Bashi formations of sections near Julfa (NW Iran) have yielded diverse nautiloid assemblages. These come from the early Wuchiapingian *Araxoceras* Beds (19 species), the late Wuchiapingian *Vedioceras* Beds (six species), the early Changhsingian *Dzhulfites* Beds (three species) and the late Changhsingian *Paratirolites* Limestone (two species). These species belong to 20 genera, eight of which are new: *Fididomatoceras* gen. nov., *Azarinautilus* gen. nov., *Serometacoceras* gen. nov., *Alibashinautilus* gen. nov., *Tardunautilus* gen. nov., *Corotainoceras* gen. nov., *Celeroliroceras* gen. nov., *Julfanautilus* gen. nov. A total of 30 species are described, of which 24 are new: *Domatoceras elegantulum* sp. nov., *Domatoceras multituberculatum* sp. nov., *Permodomatoceras hamdii* sp. nov., *Fididomatoceras intracostatum* gen. et sp. nov., *Azarinautilus nahidae* gen. et sp. nov., *Aifinautilus hebes* sp. nov., *Serometacoceras cingulum* gen. et sp. nov., *Serometacoceras inflatum* gen. et sp. nov., *Serometacoceras parvituberculatum* gen. et sp. nov., *Serometacoceras arasense* gen. et sp. nov., *Alibashinautilus vetus* gen. et sp. nov., *Alibashinautilus ambiguus* gen. et sp. nov., *Tardunautilus nimius* gen. et sp. nov., *Tardunautilus minor* gen. et sp. nov., *Tainoceras admonens* sp. nov., *Tainoceras latecostatum* sp. nov., *Tainoceras unitum* sp. nov., *Corotainoceras inerme* gen. et sp. nov., *Tainionutilus deinceps* sp. nov., *Liroceras choopani* sp. nov., *Celeroliroceras celere* gen. et sp. nov., *Peripetoceras parum* sp. nov., *Julfanautilus ashourii* gen. et sp. nov. and *Julfanautilus hairapetiani* gen. et sp. nov. The new family Julfanautilidae fam. nov. is erected to accommodate the species of *Julfanautilus* gen. nov. With 30 species, the assemblage from the area around Julfa is one of the most diverse Late Permian occurrences of coiled nautiloids. With 25 Wuchiapingian species alone, it is the most species-rich assemblage for this interval.

Keywords. Nautiloidea, Nautilida, Permian, Iran, morphology.

Korn D. & Ghaderi A. 2025. Late Permian nautiloids from Julfa (NW Iran). *European Journal of Taxonomy* 1018: 1–113. <https://doi.org/10.5852/ejt.2025.1018.3069>

Introduction

Late Permian nautiloids have a wide geographical distribution, but species-rich occurrences are restricted to a few regions. After the probably first description of the Late Permian nautiloid “*Nautilus Freieslebeni*” from the Central European Zechstein Formation by Geinitz (1841), it took several decades until almost simultaneously Mojsisovics (1869), Stache (1877), Abich (1878), Waagen (1879) and Kayser (1883) described further and sometimes more species-rich occurrences from the Dolomites (Italy), Transcaucasia (Azerbaijan), the Salt Range (Pakistan) and Jiangxi (South China), respectively. Despite the growing interest in the transition from the Palaeozoic to the Mesozoic since the end of the 19th century, it took decades to publish more comprehensive studies of Late Permian nautiloids. Reed (1931, 1944) revised the assemblages from the Salt Range and described new species. For the sites near the Araxes River in the Transcaucasus, it took even longer until the 1960s (Shimansky 1962c, 1965b).

In the last decades, rather diverse Late Permian nautiloid assemblages were described from two regions:

- (1) South China: Xu (1977), Zhao *et al.* (1978), Liang (1984), Zheng (1984), Qin (1986), Yang *et al.* (1987), Wu & Kuang (1992) and Miao *et al.* (2021) described species-rich assemblages from various places and different facies in the Jiangxi, Zhejiang, Anhui, Hubei, Sichuan, Guizhou, Hunan and Guangxi provinces.
- (2) Dolomites: Posenato & Prinoth (2004) and Prinoth & Posenato (2007) described a moderately large suite of nautiloids from the Changhsingian Bellerophon Formation and separated between eight species within five genera.

In the following, we describe newly assembled nautiloid collections from the south side of the Aras (=Araxes) river in north-western Iran (Fig. 1). These new finds come from four general stratigraphic units, (1) the early Wuchiapingian beds characterised by the ammonoid genus *Araxoceras* Ruzhencev, 1959, (2) the late Wuchiapingian beds with the ammonoid *Vedioceras* Ruzhencev, 1962, (3) the early Changhsingian beds characterised by the ammonoids *Iranites* Teichert & Kummel, 1973, *Dzhulfites* Shevyrev, 1965 and *Shevyrevites* Teichert & Kummel, 1973 and (4) the late Changhsingian *Paratirolites* Limestone (Fig. 2). This is the most stratigraphically detailed Late Permian nautiloid succession known from a single region.

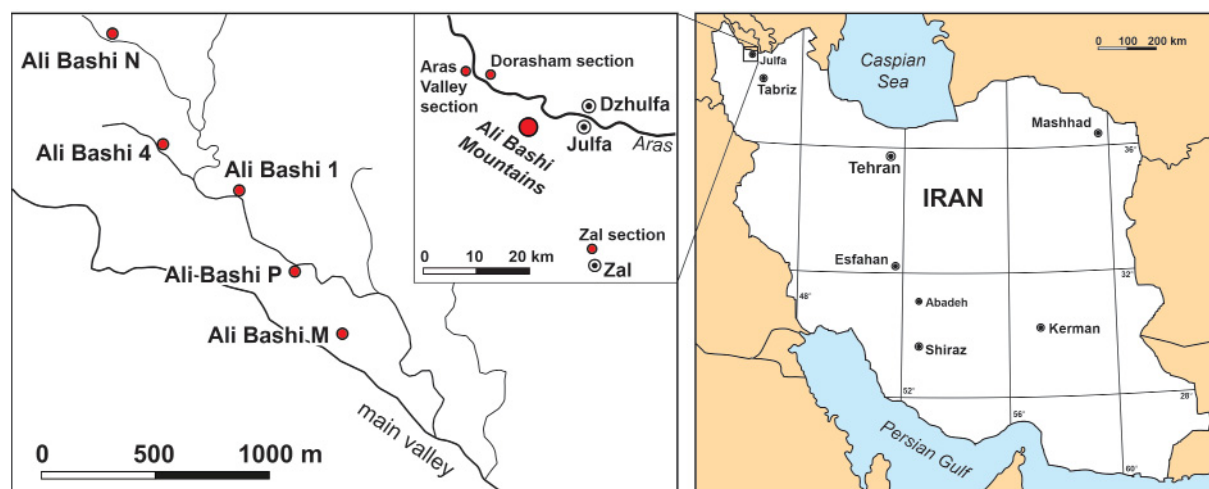

Fig. 1. Geographical position of Permian-Triassic boundary sections in the Transcaucasus-NW Iran region (after Arakelyan *et al.* 1965); the red dots represent the sections investigated in this study (from Korn *et al.* 2016).

This study complements the previous work in the sections around Julfa, which was carried out as part of a project supported by the German Research Foundation. These studies examined the general sedimentary succession and ecological changes (Leda *et al.* 2014; Schobben *et al.* 2015; Gliwa *et al.* 2020), palaeoclimatic changes (Schobben *et al.* 2014; Gliwa *et al.* 2022), succession and diversity of brachiopods (Ghaderi *et al.* 2014, 2015), ammonoids (Korn *et al.* 2016; Kiessling *et al.* 2018; Korn & Ghaderi 2019; Korn *et al.* 2019; Ghanizadeh Tabrizi *et al.* 2021), conodonts (Isaa *et al.* 2016; Gliwa *et al.* 2020) and ostracods (Gliwa *et al.* 2021).

Historical review

A detailed historical review of the earlier studies of nautiloids from Transcaucasia, and in particular from sites in the Aras Valley, was given by Teichert & Kummel (1973). They discussed the previous

| suborder | superfamily | family | genus species | Arax | Vedi | Dzhu | Para | |
|-----------------------------|-------------------|-------------------|--|--------------------------------|------|------|------|---|
| Domatoceratina | Grypoceratoidea | Domatoceratidae | <i>Domatoceras elegantulum</i> | ● | | | | |
| | | | <i>Domatoceras multituberculatum</i> | ● | | | | |
| | | | <i>Domatoceras convergens</i> | ● | | | | |
| | | | <i>Permodomatoceras hamdii</i> | ● | | | | |
| | | | <i>Fididomatoceras gracile</i> | ● | | | | |
| | | | <i>Fididomatoceras intracostatum</i> | ● | | | | |
| | | Ocunautilidae | <i>Azarinautilus nahidae</i> | ● | | | | |
| | | | <i>Ocunautilus</i> sp. | | | ○ | | |
| Tainoceratina | Pleuronautiloidea | Metacoceratidae | <i>Serometacoceras dorsoarmatum</i> | ● | | | | |
| | | | <i>Serometacoceras dorashamense</i> | ● | | | | |
| | | | <i>Serometacoceras verae</i> | ● | | | | |
| | | | <i>Serometacoceras cingulum</i> | ● | | | | |
| | | | <i>Serometacoceras inflatum</i> | ● | | | | |
| | | | <i>Serometacoceras parvituberculatum</i> | | ● | | | |
| | | | <i>Serometacoceras arasense</i> | | | ● | | |
| | | | <i>Alibashinautilus vetus</i> | ● | | | | |
| | | Rhiphaeoceratidae | <i>Alibashinautilus ambiguus</i> | | | | ● | |
| | | | <i>Alibashinautilus</i> sp. | ○ | | | | |
| | | Foordiceratidae | <i>Tardunautilus nimium</i> | ● | | | | |
| | | | <i>Tardunautilus minor</i> | ● | | | | |
| | | Pleuronautilidae | <i>Lutonautilus</i> sp. | | | ○ | | |
| | | Tainoceratoidea | Tainoceratidae | <i>Tainoceras admonens</i> | | ● | | |
| | | | | <i>Tainoceras latecostatum</i> | | ● | | |
| | | | | <i>Tainoceras unitum</i> | | | ● | |
| | | | | <i>Corotainoceras inerme</i> | ● | | | |
| | | | | <i>Tainionautilus deinceps</i> | | | | ● |
| <i>Tirolonautilus</i> sp. 1 | | | | | | ○ | | |
| <i>Tirolonautilus</i> sp. 2 | | | | | ○ | | | |
| <i>Baghuknautilus</i> sp. | | | | | | ○ | | |
| Liroceratina | Liroceratoidea | Liroceratidae | <i>Liroceras choopani</i> | ● | | | | |
| | | | <i>Celerlirocera celere</i> | ● | | | | |
| | | | <i>Celerlirocera</i> sp. | | ○ | | | |
| | | | <i>Peripetoceras parum</i> | | ● | | | |
| | | | <i>Permonautilus abichi</i> | ● | | | | |
| | | Permonautilidae | <i>Julfanautilus ashourii</i> | | ● | | | |
| | | | <i>Julfanautilus hairapetiani</i> | | ● | | | |
| | | Julfanautilidae | <i>Julfanautilus ashourii</i> | | ● | | | |
| | | | <i>Julfanautilus hairapetiani</i> | | ● | | | |
| | | | <i>Baghuknautilus</i> sp. | | | | ○ | |

Fig. 2. Stratigraphical positions of the Late Permian nautiloid taxa from the region of Julfa. Arax=Araxoceras Beds; Vedi=Vedioceras Beds; Dzhu=Dzhulfites Beds; Para=Paratirolites Limestone.

pioneering studies, which mainly focused on the famous Dorasham locality, 10–16 km west of the towns of Dzhulfa (Nakhichevan Province, Azerbaijan) and Julfa (East Azerbaijan Province, Iran) on the northern side of the Aras River.

In the first description of nautiloids from Dorasham, Abich (1878) distinguished between 18 species (Figs 3–5), six of which are straight and 12 are coiled (original names and revisions):

“*Nautilus excentricus* Eichwald” = *Permonautilus abichi* (Kruglov, 1928)
“*Nautilus propinquus*, nov. form.” = *Permonautilus abichi* (Kruglov, 1928)
“*Nautilus parallelus*, nov. form.” = *Domatoceras parallelum* (Abich, 1878)

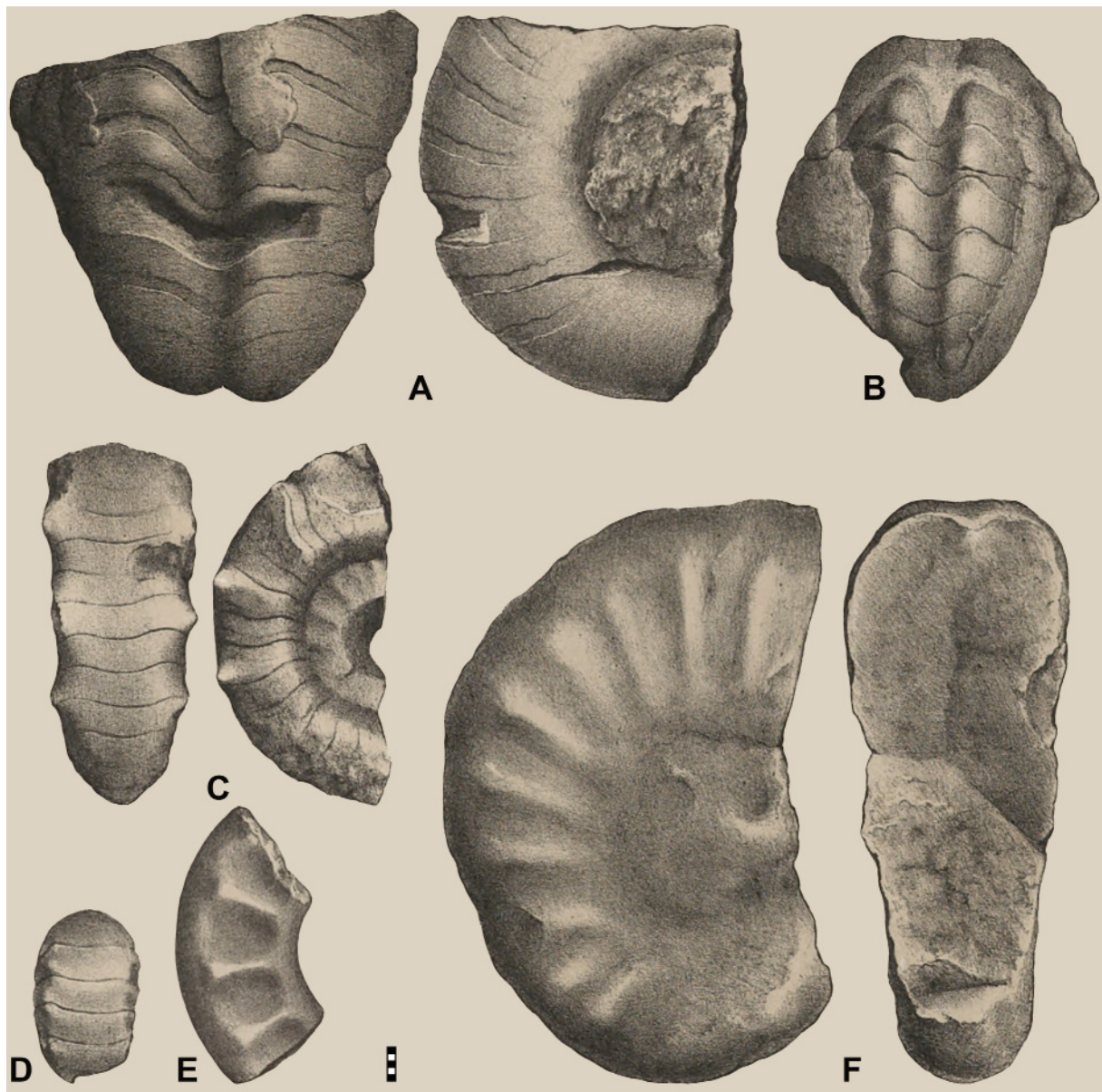

Fig. 3. Reproductions of nautiloid figures of Abich (1878). **A.** “*Nautilus dorso plicatus*” Abich, 1878. **B.** “*Nautilus dorso plicatus*”. **C.** “*Nautilus dorso armatus*” Abich, 1878. **D.** “*Nautilus incertus*” von Arthaber, 1900. **E.** “*Nautilus Pichleri*” von Arthaber, 1900. **F.** “*Nautilus tubercularis*” Abich, 1878. Scale bar units = 1 mm.

| | |
|--|--|
| “ <i>Nautilus convergens</i> , nov. form.” | = <i>Domatoceras convergens</i> (Abich, 1878) |
| “ <i>Nautilus concavus</i> Sowerby” | = <i>Permonautilus abichi</i> (Kruglov, 1928) |
| “ <i>Nautilus dolerus</i> , nov. form.” | = unknown |
| “ <i>Nautilus dorso armatus</i> , nov. form.” | = <i>Serometacoceras dorsoarmatum</i> (Abich, 1878) gen. et comb. nov. |
| “ <i>Nautilus Pichleri</i> von Hauer” | = <i>Serometacoceras verae</i> (von Arthaber, 1900) gen. et comb. nov. |
| “ <i>Nautilus tubercularis</i> , nov. form.” | = <i>Serometacoceras tubercularis</i> (Abich, 1878) gen. et comb. nov. |
| “ <i>Nautilus dorso plicatus</i> , nov. form.” | = <i>Tainoceras dorsoplicatum</i> (Abich, 1878) |
| “ <i>Nautilus armeniacus</i> , nov. form.” | = <i>Pseudotitanoceras armeniacum</i> (Abich, 1878) |
| “ <i>Nautilus incertus</i> ” | = <i>Serometacoceras verae</i> (von Arthaber, 1900) |

Von Arthaber (1900) added the new coiled nautiloid species “*Pleurometaceras Verae*”, now *Serometacoceras verae* (von Arthaber, 1900) gen. et comb. nov. and Stoyanow (1910) added one new straight nautiloid species and one additional first record of a coiled nautiloid.

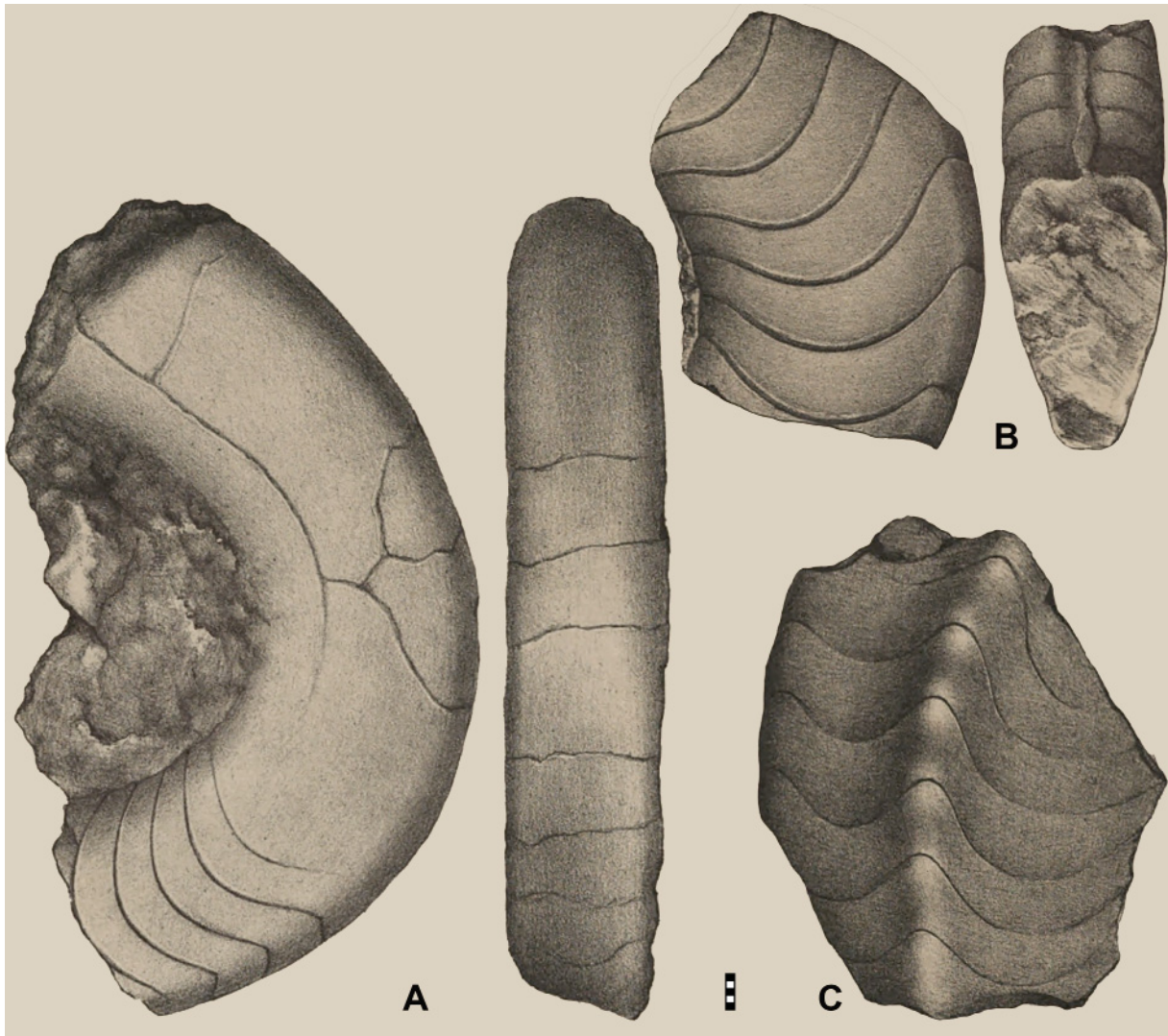

Fig. 4. Reproductions of nautiloid figures of Abich (1878). **A.** “*Nautilus parallelus*” Abich, 1878. **B.** “*Nautilus convergens*” Abich, 1878. **C.** “*Nautilus armeniacus*” Abich, 1878. Scale bar units = 1 mm.

The first monographic description of the Late Permian nautiloids from the Transcaucasus was published by Shimansky (1965b) who described 22 species of coiled nautiloids from the *Araxoceras* Beds, eleven from the *Vedioceras* Beds (both belonging to the Wuchiapingian), five from the “*Phisonites* Beds” (=Zal Member) and seven from the *Paratirolites* Limestone (both belonging to the Changhsingian). For the straight nautiloids, the respective numbers were 6, 2, 1 and 1. It must be kept in mind that 60 percent of the taxa listed by Shimansky (1965b: table 5) were held in open nomenclature. Nevertheless, Teichert & Kummel (1973) correctly stated that this is an impressive list, which demonstrates a high diversity, particularly for the lower Julfa beds (*Araxoceras* Beds).

Teichert *et al.* (1973) and Teichert & Kummel (1973) investigated sections west of Julfa on the southern (Iranian) side of the Aras valley. They found essentially the same nautiloid assemblages, but comparison with the faunal list provided by Shimansky (1965b) shows that some taxa were missing, but also reported the presence of the three additional genera *Temnocheilus*, *Tainionautilus* and *Titanoceras* in the Iranian assemblages. After this study, nautiloids from the entire Transcaucasian region were only occasionally mentioned.

Shimansky (1979b) added three additional taxa (*Araxonautilus nodosus* Shimansky, 1979, *A. sp.* and *Pararhiphaeoceras probum* Shimansky, 1979) to the species list of the Late Permian nautiloids of the Transcaucasus. Kotlyar *et al.* (1983) provided occurrence lists of Late Permian fossils from various places in Armenia and Azerbaijan including nautiloid species, but they did not provide illustrations of their material. Zakharov (in Kotlyar *et al.* 1989) described the new Middle Permian species “*Pleuromautilus dzhagadzurensis* Zakharov in Kotlyar *et al.*, 1989”. Gliwa *et al.* (2020) illustrated a selection of the material described in the present study.

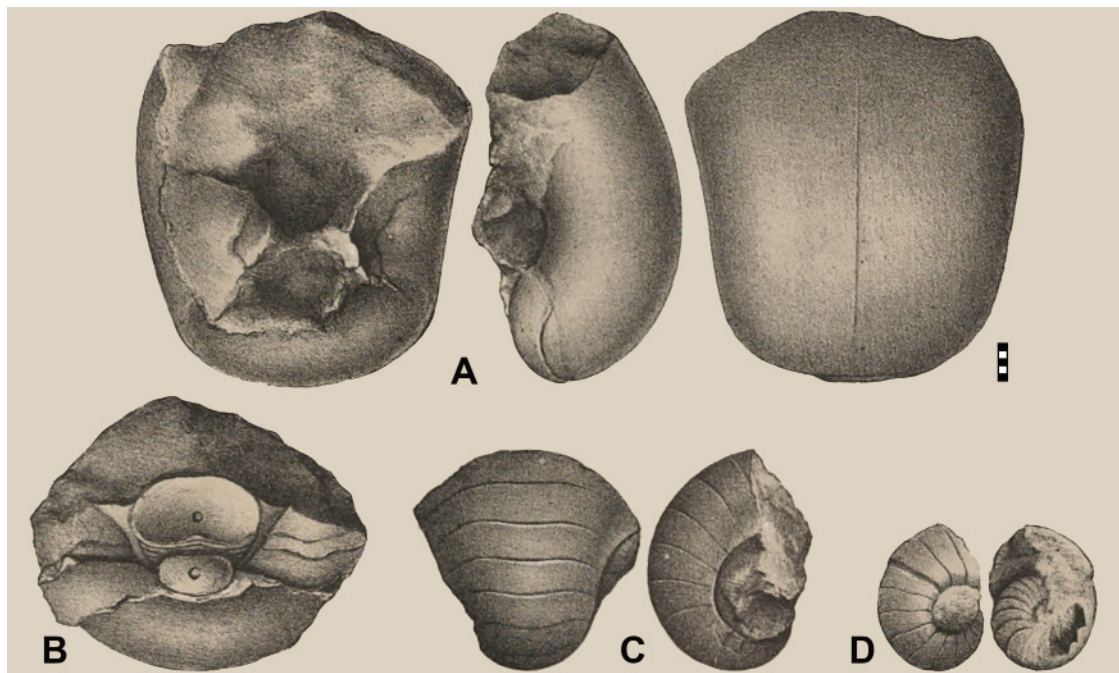

Fig. 5. Reproductions of nautiloid figures of Abich (1878). **A.** “*Nautilus concavus*” Sowerby, 1840. **B.** “*Nautilus concavus*”. **C.** “*Nautilus excentricus*” Eichwald, 1857. **D.** “*Nautilus propinquus*” Kruglov, 1928. Scale bar units for all figures=1 mm.

Material and methods

Specimens studied

We investigated a total of 123 specimens from the Julfa and the Ali Bashi formations. The majority of the specimens were collected from float material below the outcrops. However, based on their lithology, all the specimens described here can be undoubtedly assigned to a member of the Julfa and Ali Bashi formations. Four members have been distinguished from bottom to top with the following species that are represented (Fig. 2):

(1) *Araxoceras* Beds (early Wuchiapingian): light grey micritic nodular limestone (102 specimens)

- *Domatoceras elegantulum* sp. nov. – 9 specimens
- *Domatoceras multituberculatum* sp. nov. – 6 specimens
- *Domatoceras convergens* (Abich, 1878) – 3 specimens
- *Permodomatoceras hamdii* sp. nov. – 10 specimens
- *Fididomatoceras gracile* (Shimansky, 1965) gen. et comb. nov. – 1 specimen
- *Fididomatoceras intracostatum* gen. et sp. nov. – 2 specimens
- *Azarinautilus nahidae* gen. et sp. nov. – 4 specimens
- *Aifinautilus hebes* sp. nov. – 1 specimen
- *Serometacoceras dorsoarmatum* (Abich, 1878) gen. et comb. nov. – 3 specimens
- *Serometacoceras dorashamense* (Shimansky, 1965) gen. et comb. nov. – 16 specimens
- *Serometacoceras verae* (von Arthaber, 1900) gen. et comb. nov. – 8 specimens
- *Serometacoceras cingulum* gen. et sp. nov. – 1 specimen
- *Serometacoceras inflatum* gen. et sp. nov. – 1 specimen
- *Alibashinautilus vetus* gen. et sp. nov. – 3 specimens
- *Alibashinautilus* sp. – 1 specimen
- *Tardunautilus minor* gen. et sp. nov. – 1 specimen
- *Corotainoceras inerme* gen. et sp. nov. – 1 specimen
- *Liroceras choopani* sp. nov. – 6 specimens
- *Celeroliroceras celere* gen. et sp. nov. – 1 specimen
- *Permonautilus abichi* (Kruglov, 1928) – 24 specimens

(2) *Vedioceras* Beds (late Wuchiapingian): pink or light grey nodular limestone (10 specimens)

- *Serometacoceras parvituberculatum* gen. et sp. nov. – 1 specimen
- *Tainoceras admonens* sp. nov. – 2 specimens
- *Tainoceras latecostatum* sp. nov. – 1 specimen
- *Celeroliroceras* sp. – 1 specimen
- *Peripetoceras parum* sp. nov. – 2 specimens
- *Julfanautilus ashourii* gen. et sp. nov. – 1 specimen
- *Julfanautilus hairapetiani* gen. et sp. nov. – 1 specimen
- gen. indet. sp. indet. – 1 specimen

(3) *Dzhulfites* Beds (early Changhsingian): grey nodular limestone with high clay content (7 specimens)

- *Ocunautilus* sp. – 2 specimens
- *Serometacoceras arasense* gen. et sp. nov. – 1 specimen
- *Tardunautilus nimius* gen. et sp. nov. – 1 specimen
- New genus C to be described by Korn & Hairapetian (in press) – 1 specimen
- *Tainoceras unitum* sp. nov. – 1 specimen
- *Tirolonautilus* sp. 2 – 1 specimen

(4) *Paratirolites* Limestone (late Changhsingian): pink to dark red nodular limestone (4 specimens)

- *Alibashinautilus ambiguus* gen. et sp. nov. – 1 specimen
- *Tainionutilus deinceps* sp. nov. – 1 specimen

- *Tirolonautilus* sp. 1 – 1 specimen
- New genus F to be described by Korn & Hairapetian (in press) – 1 specimen

Taxonomic concept

For the order Nautilida in current understanding, several partially conflicting concepts of systematics have been published and modified over the decades. While Flower & Kummel (1950) and Kummel (1953, 1964) took a more conservative approach, Shimansky (1962a, 1962b, 1965b, 1967) proposed a much more detailed scheme. Dzik (1984) discussed the phylogeny and its implications for the systematic scheme in great detail and drew a much more complex evolutionary history of the coiled nautiloids.

In a revision of the Carboniferous and Permian coiled nautiloids by Korn (2025), a new systematic scheme was presented. This scheme is largely based on the phylogenetic considerations of Ruzhencev & Shimansky (1954) as well as Dzik (1984) and is largely based, with some modifications, on the systematic scheme of Shimansky (1967, 1979a). This also means that it differs from the frequently used scheme of the *Treatise on Invertebrate Paleontology* (Kummel 1964).

The description of the specimens follows the terminology of conch, ornament and suture line proposed by Korn (2010) and Klug *et al.* (2015) for the characterisation of ammonoids (Fig. 6). The terminology of conch geometry used here largely corresponds to that proposed by Teichert (1964). The only differences concern the following terms: umbilical angle or shoulder (=umbilical margin) and umbilical area (=umbilical width).

The lists of genera and species are not exhaustive. When listing species within genera, the stratigraphic unit and the region of the type material have been added. Species have been named according to their original genus assignment.

Abbreviations used in the species descriptions

- ah = apertural height
- dm = conch diameter
- IZR = imprint zone rate
- SD = septal density (distance of septa in degrees)
- uw = umbilical width
- WER = whorl expansion rate

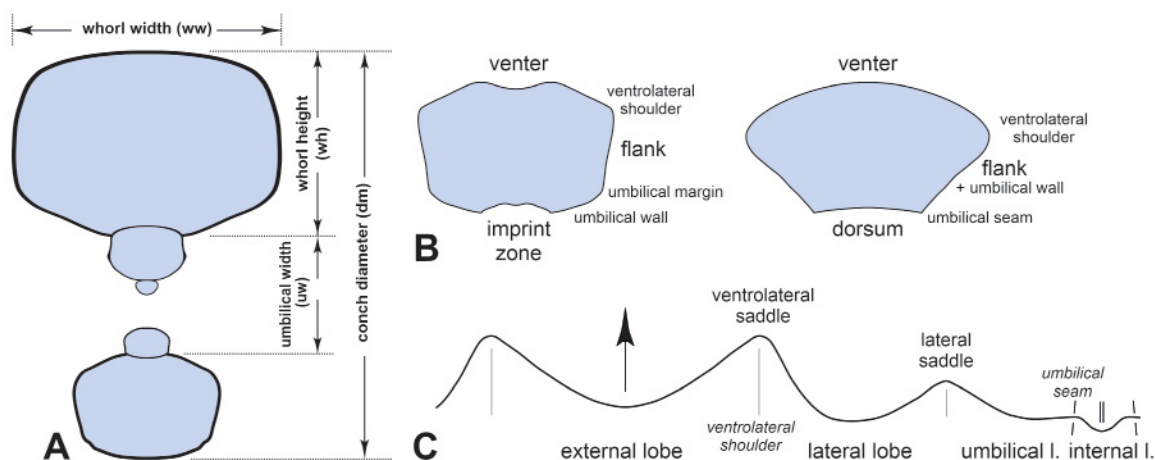

Fig. 6. Conch and suture line parameters used in the taxonomic descriptions. **A.** Conch parameters. **B.** Descriptive terms of whorl profiles. **C.** Suture line terminology. Abbreviation: l. = lobe.

wh = whorl height
ww = whorl width

Abbreviations of the repositories

MB.C. = Cephalopod collection of the Museum für Naturkunde, Berlin, Germany
GLM = Golfaraj Ecomuseum, Julfa, Iran
PIN = Palaeontological Institute of the Academy of Sciences, Moscow, Russian Federation
LGI = Leningradskiy Gorniy Institut, Leningrad (now Sankt-Peterburgskiy Gorniy Universitet, St. Peterburg), Russian Federation

Results

Class Cephalopoda Cuvier, 1795
Subclass Nautiloidea Agassiz, 1847
Order **Nautilida** Agassiz, 1847

Diagnosis

Exogastrically curved or coiled nautiloids with a conch shape ranging from gyroconic or cyrtconic to more or less tightly coiled. Shell surface smooth or sculptured with a variety of elements (ribs, nodes, spines, longitudinal ridges or lines). Septa simply domed in most species, with the shape of the whorl profile producing suture lines with variable lobes and saddles. Variations in septal shape with inflexions producing deep lobes in some genera. Septal necks short and straight, rarely slightly widened. Connective rings cylindrical or beaded. Siphuncular or cameral deposits absent. Juvenile conch with cup-shaped initial chamber and narrow siphuncle. Morphological evolution includes the degree of coiling, the shape and size of the juvenile and adult conch and the suture line (after Shimansky 1962b; emended).

Included suborders

Nautilina Agassiz, 1847 (Jurassic to Recent); Solenochilina Flower, 1950 (Carboniferous to Permian); Liroceratina Flower, 1955 (Carboniferous to Jurassic); Rutoceratina Shimansky, 1957 (Devonian); Tainoceratina Shimansky, 1957 (Carboniferous to Triassic); Temnocheilina Flower, 1963 (Devonian to Permian); Domatoceratina Korn, 2025 (Carboniferous to Triassic).

Suborder **Domatoceratina** Korn, 2025

Diagnosis

Suborder of the order Nautilida, in which a ventrolateral shoulder and an umbilical margin are formed early in ontogeny. Conch usually discoidal, subinvolute to evolute. Juvenile whorl profile circular. Adult whorl profile subquadrate or inverted trapezoidal with a distinct ventrolateral shoulder and a distinct umbilical margin in the early species, showing modifications during evolution including a concave venter in some derived species. Dorsal whorl zone always present, but usually very small except for some derived species. Juvenile sculpture sometimes with radial ribs on the flank; adult sculpture is usually lacking except for elongate ventrolateral tubercles in derived species. Septa simply domed in most of the species; with septal inflexion or corrugated septa in some lineages. Suture line usually depending on the whorl profile, usually with shallow lobes and low saddles; with distinct lobes in one clade (from Korn 2025).

Included superfamilies

Grypoceratoidea Hyatt, 1900 (Carboniferous to Triassic); Permoceratoidea Miller & Collinson, 1953 (Permian); Subclymenioidea Shimansky, 1962 (Carboniferous).

Remarks

A detailed discussion of the Domatoceratina has been given by Korn (2025).

Superfamily **Grypoceratoidea** Hyatt, 1900

Diagnosis

Superfamily of the suborder Domatoceratina with a discoidal, subinvolute to evolute conch. Whorl profile usually inverted trapezoidal with a distinct ventrolateral shoulder and a distinct umbilical margin. Derived species show a variation of modifications including a concave venter, a skid-like ventrolateral shoulder and an angular umbilical margin. Whorl overlap extremely small to moderate. Sculpture in most species lacking, in some species with short lateral ribs or ventrolateral nodes. Septa simply domed; suture line strongly dependent on the whorl profile, usually with broadly rounded lobes and narrowly rounded or subangular saddles (from Korn 2025).

Included families

Grypoceratidae Hyatt, 1900; Domatoceratidae Miller & Youngquist, 1949; new family to be described by Korn & Hairapetian (in press).

Remarks

A discussion of the Grypoceratoidea has been given by Korn (2025).

Family **Domatoceratidae** Miller & Youngquist, 1949

Diagnosis

Family of the superfamily Grypoceratoidea with a thinly to thickly discoidal, subinvolute to evolute conch. Whorl profile in the adult stage usually compressed subquadrate or inverted trapezoidal. Umbilical margin distinct or sharp; ventrolateral shoulder nearly rectangular to broadly rounded, rarely skid-like. Ornament consisting of fine growth lines; some species have tubercles on the ventrolateral shoulder. Suture line always with rounded but distinct external, lateral and internal lobes separated by a narrowly rounded or subacute saddles; without annular process (from Korn 2025).

Included genera

Pselioceras Hyatt, 1884 (Permian); *Titanoceras* Hyatt, 1884 (Carboniferous); *Domatoceras* Hyatt, 1891 (Carboniferous to Permian); *Pseudometacoceras* Miller, Dunbar & Condra, 1933 [synonym of *Domatoceras* Hyatt, 1891]; *Paradomatoceras* Delépine, 1937 (Carboniferous); *Plummeroceras* Kummel, 1953 (Permian); *Neodomatoceras* Ruzhencev & Shimansky, 1954 (Permian); *Neostenopoceras* Zhao, Liang & Zheng, 1978 (Permian); *Parapenascoceras* Ruzhencev & Shimansky, 1954 (Permian); *Parastenopoceras* Ruzhencev & Shimansky, 1954 (Permian); *Penascoceras* Ruzhencev & Shimansky, 1954 (Permian); *Permodomatoceras* Ruzhencev & Shimansky, 1954 (Permian); *Stenodomatoceras* Ruzhencev & Shimansky, 1954 (Permian); *Virgaloceras* Schindewolf, 1954 (Permian); *Neostenopoceras* Zhao, Liang & Zheng, 1978 (Permian); *Shatoceras* Leonova & Shchedukhin, 2020 (Permian); *Omorphoceras* Leonova & Shchedukhin, 2023 (Permian); *Fididomatoceras* gen. nov. (Permian).

Remarks

A detailed discussion of the Domatoceratidae has been given by Korn (2025).

Genus **Domatoceras** Hyatt, 1891

Type species

Domatoceras umbilicatum Hyatt, 1891; original designation.

Diagnosis

Genus of the family Domatoceratidae with a subinvolute to evolute conch. High to extremely high coiling rate; whorl profile usually weakly compressed. Venter flattened or weakly concave, flanks usually flattened and slightly convergent; umbilical margin rounded or angular. Without sculpture except for small ventrolateral tubercles in some species. Suture line with small and shallow external lobe and broadly rounded lateral lobe; without annular process.

Included Carboniferous species

North America (Meek & Worthen 1865; Worthen & Meek 1875; Gurley 1883; Hyatt 1891; Miller & Owen 1934; Sturgeon & Miller 1948; Tucker 1976; Tucker & Mapes 1978; Sturgeon *et al.* 1982; Niko & Mapes 2016; Niko *et al.* 2022): *Nautilus Lasallensis* Meek & Worthen, 1865, Kasimovian, Illinois; *Nautilus (Discites) highlandensis* Worthen in Worthen & Meek, 1875, Moscovian, Ohio; *Discites Toddanus* Gurley, 1883, Kasimovian, Missouri; *Domatoceras umbilicatum* Hyatt, 1891, Moscovian, Kansas; *Domatoceras williamsi* Miller & Owen, 1934, Moscovian, Ohio; *Domatoceras obsoletum* Sturgeon, 1946, Moscovian, Ohio; *Domatoceras shepherdi* Sturgeon, 1948, Moscovian, Ohio; *Domatoceras wortheni* Tucker, 1976, Kasimovian, Illinois; *Domatoceras texanum* Tucker & Mapes, 1978, Kasimovian, Texas; *Domatoceras oreskovichi* Sturgeon, Windle, Mapes & Hoare, 1982, Moscovian, Ohio; *Domatoceras collinsvillense* Niko & Mapes, 2016, Moscovian, Oklahoma; *Domatoceras tuckeri* Niko, Mapes & Seuss, 2022, Kasimovian, Texas.

South China (Ruan & Zhou 1987): *Domatoceras quadratum* Ruan & Zhou, 1987, Bashkirian, Ningxia.

West Russia (Tzwetaev 1888, 1898; Shimansky 1967): *Nautilus podolskensis* Tzwetaev, 1888, Moscovian Moscow Basin; *Nautilus mosquensis* Tzwetaev, 1898, Moscovian Moscow Basin; *Domatoceras (Domatoceras) magister* Shimansky, 1967, Moscovian, Moscow Basin.

Included Permian species

Urals (Leonova & Shchedukhin 2020): *Domatoceras bashkiricum* Leonova & Shchedukhin, 2020, Asselian or Sakmarian, South Urals; *Domatoceras sterlitamakense* Leonova & Shchedukhin, 2020, Asselian or Sakmarian, South Urals.

Transcaucasia and Iran (Abich 1878; Shimansky 1965b; Korn & Hairapetian in press), this paper: *Nautilus parallelus* Abich, 1878, Wuchiapingian, Azerbaijan; *Nautilus convergens* Abich, 1878, Wuchiapingian, Azerbaijan; *Domatoceras gracile* Shimansky, 1965, Wuchiapingian, Azerbaijan; *Domatoceras atypicum* Shimansky, 1965, Wuchiapingian, Azerbaijan; new species A to be described by Korn & Hairapetian (in press), Wuchiapingian, Central Iran; new species B to be described by Korn & Hairapetian (in press), Wuchiapingian, Central Iran; new species C to be described by Korn & Hairapetian (in press), Wuchiapingian, Central Iran; *Domatoceras elegantulum* sp. nov., Wuchiapingian, NW Iran; *Domatoceras multituberculatum* sp. nov., Wuchiapingian, NW Iran.

South China (Zhao *et al.* 1978; Ma 1997): *Domatoceras guangxiense* Zhao, Liang & Zheng, 1978, Changhsingian, Guangxi; *Domatoceras jiangxiense* Ma, 1997, Wuchiapingian, Jiangxi; *Domatoceras inflatum* Ma, 1997, Wuchiapingian, Jiangxi.

Japan (Ehiro & Takizawa 1989): *Domatoceras ogatsuense* Ehiro & Takizawa, 1989, Wuchiapingian.

Remarks

The species of the genus *Domatoceras* have a very similar conch morphology from the Moscovian to the Changhsingian, suggesting a very conservative evolutionary lineage. Shimansky (1967) also included some Serpukhovian species in *Domatoceras*, but these differ from the typical representatives of the

genus in that they have a wider conch and lack a subangular or angular ventrolateral shoulder. These stratigraphically older species may belong to *Epidomatoceras*.

The similarity in the morphology of the conchs, the virtual absence of sculptural elements and the fact that the suture line depends essentially on the shape of the whorl profile make it difficult to distinguish the species within *Domatoceras*. Another difficulty is that the species of the genus occur in two phases: the first phase extends from the Moscovian to the Asselian–Sakmarian boundary, and the second phase extends from the Wuchiapingian to the Changhsingian. It should be noted, however, that of the Late Permian species, about ten are known from the Wuchiapingian and only one from the Changhsingian. Apparently, no species are known from the long interval between the Sakmarian and the Capitanian. Some species from the Kungurian and Roadian, which were placed under *Domatoceras* by Miller & Unklesbay (1942) and Miller & Youngquist (1949), have been assigned to other genera such as *Penascoceras* by Ruzhencev & Shimansky (1954).

Domatoceras elegantulum sp. nov.

urn:lsid:zoobank.org:act:0381E5AC-01EE-421B-BB83-723466020686

Figs 7–8; Table 1

Nautilus parallelus – von Arthaber 1900: 213, pl. 18 fig. 2.

Domatoceras parallelus – Shimansky 1965a: 41, pl. 15 fig. 10.

Domatoceras parallelum – Teichert & Kummel 1973: 421, pl. 2 figs 1–2, 9–10. — Gliwa *et al.* 2020: text-fig. 17a.

Diagnosis

Species of *Domatoceras* with extremely discoidal, subevolute conch ($ww/dm \sim 0.25$; $uw/dm \sim 0.35$), weakly compressed, inverted trapezoidal whorl profile ($ww/wh \sim 0.70$) and very high to extremely high coiling rate ($WER = 2.30–2.60$) at a conch diameter of 75–100 mm. Whorl profile with flattened venter, subangular ventrolateral shoulder, gently convergent, flattened flanks and rounded umbilical margin. Ornament with fine growth lines, without ribs or nodes. Suture line with a narrow and shallow external lobe and a much larger and deeper, broadly rounded lateral lobe.

Etymology

The epithet comes from the Latin ‘*elegantulum*’ (adj., n.)=‘very fine’; because of the elegant conch shape.

Type material

Holotype

IRAN – **West Azerbaijan** • Aras Valley; *Araxoceras* Beds of the Julfa Formation (early Wuchiapingian); 2011; Korn *et al.* leg.; illustrated in Fig. 7; MB.C.29346.

Paratypes

IRAN – **West Azerbaijan** • 1 specimen; same data as for holotype; illustrated in Fig. 8A–D; MB.C.31989 • 4 specimens; same data as for holotype; 2018; Ghaderi leg.; MB.C.31993 to MB.C.31996. – **East Azerbaijan** • 1 specimen; Zal; *Araxoceras* Beds of the Julfa Formation (early Wuchiapingian); 2018; Ghaderi leg.; illustrated in Fig. 8E–F; MB.C.31990 • 1 specimen; Ali Bashi 4; *Araxoceras* Beds of the Julfa Formation (early Wuchiapingian); 2010; Korn *et al.* leg.; MB.C.31991 • 1 specimen; Ali Bashi N; *Araxoceras* Beds of the Julfa Formation (early Wuchiapingian); 2011; Korn *et al.* leg.; MB.C.31992.

Description

Holotype MB.C.29346 is the largest of the fairly complete specimens (Fig. 7B). It has a conch diameter of nearly 100 mm and is chambered except for a short segment that belongs to the body chamber. The

Table 1. Conch dimensions (in mm) and ratios of *Domatoceras elegantulum* sp. nov.

| Nr. | dm | ww | wh | uw | ah | ww/dm | ww/wh | uw/dm | WER | IZR |
|------------|------|------|------|------|------|-------|-------|-------|------|------|
| MB.C.29346 | 98.5 | 25.6 | 36.2 | 35.9 | 33.8 | 0.26 | 0.71 | 0.36 | 2.32 | 0.07 |
| MB.C.31989 | 75.2 | 19.7 | 30.0 | 26.6 | 28.4 | 0.26 | 0.66 | 0.35 | 2.58 | 0.05 |
| MB.C.31992 | – | 24.5 | 38.8 | – | – | – | 0.63 | – | – | – |
| MB.C.31996 | – | 26.0 | 38.2 | – | – | – | 0.68 | – | – | – |
| MB.C.31995 | – | 23.8 | 33.7 | – | – | – | 0.71 | – | – | – |
| MB.C.31990 | – | 10.5 | 15.3 | – | – | – | 0.69 | – | – | – |
| MB.C.31994 | – | 10.4 | 14.1 | – | – | – | 0.74 | – | – | – |

conch is extremely discoidal ($ww/dm=0.26$) and subevolute ($uw/dm=0.36$) with a very high coiling rate ($WER=2.32$). The whorl profile is weakly compressed ($ww/wh=0.71$) and inverted trapezoidal; it is widest at the rounded umbilical margin, from where the flattened flanks slowly converge towards the subangular ventrolateral shoulder (Fig. 7A). The venter is flat at the largest diameter but slightly concave earlier on the last preserved volution. The suture line shows a rather narrow and broadly rounded external lobe with flanks diverging slightly more than 90 degrees (Fig. 7C). The curvature of the ventrolateral saddle is similar to that of the external lobe and is positioned at the ventrolateral shoulder. The flanks are

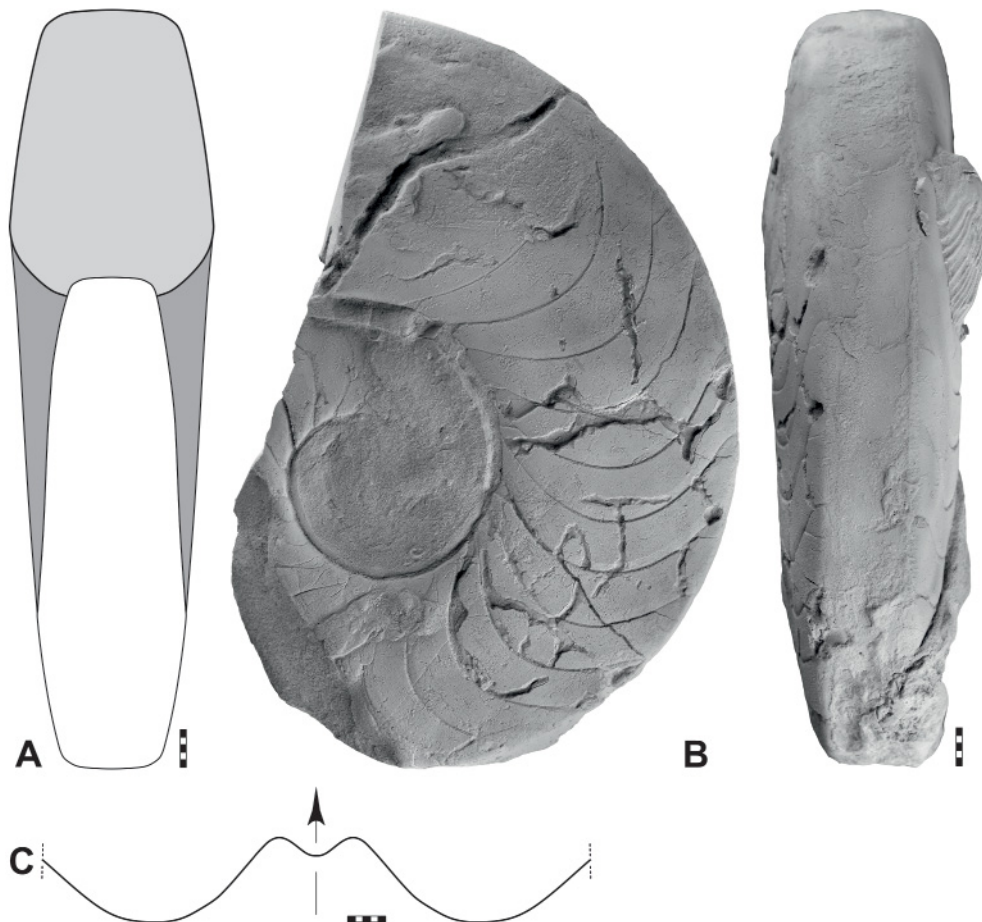

Fig. 7. *Domatoceras elegantulum* sp. nov., holotype MB.C.29346 (Korn *et al.* 2011 Coll.) from the *Araxoceras* Beds of the Julfa Formation at Aras Valley. **A.** Reconstruction of apertural view. **B.** Lateral and ventral views. **C.** Suture line at $ww=22.2$ mm, $wh=30.1$ mm. Scale bar units=1 mm.

occupied by the broadly rounded lateral lobe, which is about half as deep as wide. The last volution of the phragmocone has 22 septa, which are rather regularly spaced ($SD \sim 16$ degrees).

Paratype MB.C.31989 (Fig. 8A–C) is a nearly complete internal mould specimen with a conch diameter of 75 mm. Only the last whorl is fairly well preserved, two thirds of this belong to the phragmocone and one third to the body chamber. The specimen closely resembles, in the conch proportions, the holotype and is extremely discoidal and subevolute with a compressed whorl profile ($ww/dm=0.26$; $uw/dm=0.35$; $ww/wh=0.66$). The venter changes from flatly rounded to nearly flat during the last volution; in parallel, the ventrolateral shoulder changes from narrowly rounded to subangular. The flanks are flattened and slowly converge toward the venter. The suture line has a very shallow external lobe and a shallow lateral lobe (Fig. 8D). The last half volution of the phragmocone possesses 13 septa standing in rather regular distances ($SD \sim 14$ degrees).

The smaller fragment MB.C.31990 (14 mm whorl height) provides an insight in the juvenile outline of the whorl profile and the suture line (Fig. 8F). It demonstrates that the shape of the whorl profile and also the course of the suture line probably does not change much during ontogeny.

Remarks

The new species has some resemblance with “*Nautilus parallelus* Abich, 1878”, but it can be seen from the description and illustration by Abich (1878: 17, pl. 2 fig. 2) that the umbilicus is rather wide ($uw/dm \sim 0.45$) in that species and that the flanks are almost parallel. This species has thus a much wider

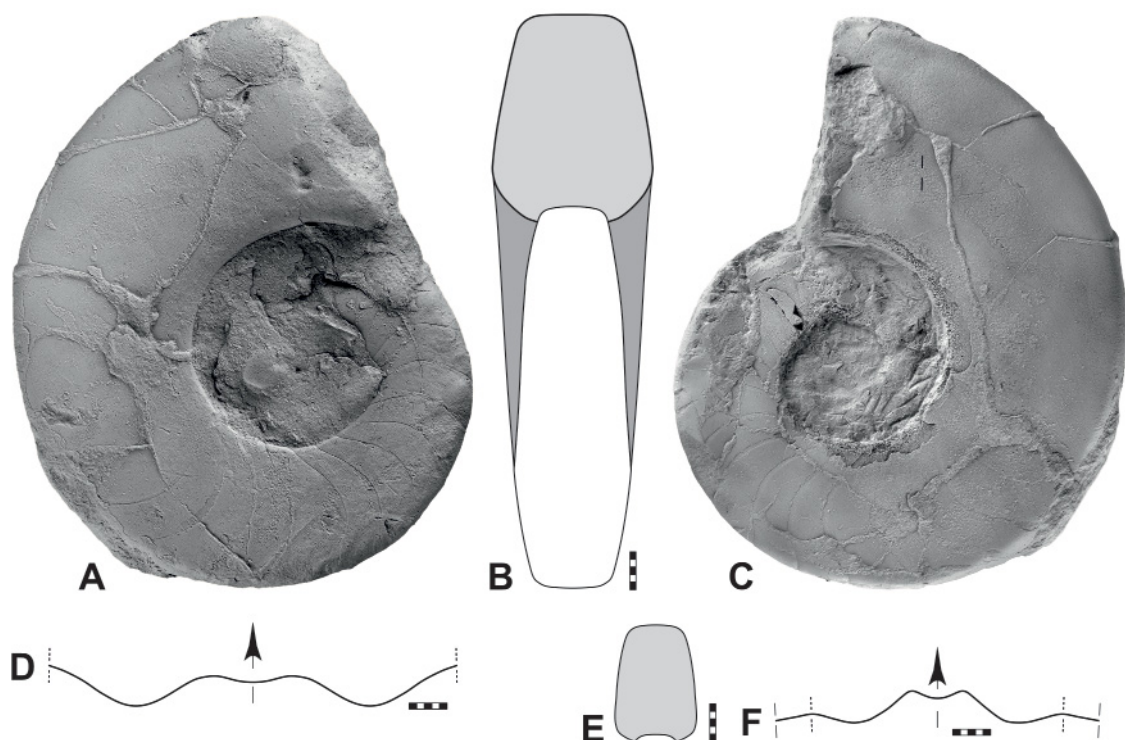

Fig. 8. *Domatoceras elegantulum* sp. nov. **A.** Paratype MB.C.31989 (Korn *et al.* 2011 Coll.) from the *Araxoceras* Beds of the Julfa Formation at Ali Bashi, lateral view of left side. **B.** The same specimen, reconstruction of apertural view. **C.** The same specimen, lateral view of right side. **D.** The same specimen, suture line at $ww=14.0$ mm, $wh=17.8$ mm. **E.** Paratype MB.C.31990 (Ghaderi 2018 Coll.) from Zal, whorl profile. **F.** The same specimen; suture line at $ww=10.4$ mm, $wh=14.3$ mm. Scale bar units=1 mm.

umbilicus than *D. elegantulum* sp. nov. (uw/dm ~0.35) and differs also in the parallel flanks (convergent in *D. elegantulum*).

Domatoceras elegantulum sp. nov. differs from *D. multituberculatum* sp. nov. in the lack of ventrolateral nodes of the inner whorls, the slightly less evolute (uw/dm ~0.35 in contrast to ~0.38) and slenderer conch, the more compressed whorl profile and the broadly rounded umbilical margin.

Domatoceras elegantulum sp. nov. differs from *D. convergens* by the less strongly convergent flanks and the slightly wider whorl profile (ww/wh ~0.65 in contrast to *D. convergens* with ~0.60) at a conch diameter of 75 mm. The venter is much wider in *D. elegantulum* when compared to *D. convergens*.

***Domatoceras multituberculatum* sp. nov.**

urn:lsid:zoobank.org:act:8B3BEF64-3F0E-4629-A675-8E1F016ACD7E

Fig. 9; Table 2

Diagnosis

Species of *Domatoceras* with extremely discoidal, subevolute conch (ww/dm ~0.28; uw/dm ~0.38), weakly compressed, inverted trapezoidal whorl profile (ww/wh ~0.75) and very high coiling rate (WER ~2.35) at a conch diameter of 75–100 mm. Whorl profile with flat venter, subangular ventrolateral shoulder, gently convergent, flattened flanks and narrowly rounded umbilical margin. Ornament with fine growth lines and with small ventrolateral conical tubercles in the preadult stage. Suture line with a narrow and shallow external lobe and a much larger and deeper, broadly rounded lateral lobe.

Etymology

Combination of the Latin ‘*multus*’ (adj., m.)=‘many’ and ‘*tuberculum*’ (noun, n.)=‘tubercle’; because of the ventrolateral sculpture.

Type material

Holotype

IRAN – **West Azerbaijan** • Aras Valley; *Araxoceras* Beds of the Julfa Formation (early Wuchiapingian); 2011; Korn *et al.* leg.; illustrated in Fig. 9A–D; MB.C.31997.

Paratypes

IRAN – **West Azerbaijan** • 1 specimen; same data as for holotype; illustrated in Fig. 9G–I; MB.C.31998 • 1 specimen; Aras Valley; *Araxoceras* Beds of the Julfa Formation (early Wuchiapingian); 2018; Ghaderi leg.; illustrated in Fig. 9G–I; MB.C.31999 • 1 specimen; Aras Valley; *Araxoceras* Beds of the Julfa Formation (early Wuchiapingian); 2018; Ghaderi leg.; illustrated in Fig. 9J–K; MB.C.32000 • 1 specimen; Aras Valley; *Araxoceras* Beds of the Julfa Formation (early Wuchiapingian); 2018; Ghaderi leg.; MB.C.32001. – **East Azerbaijan** • 1 specimen; Ali Bashi 4; *Araxoceras* Beds of the Julfa Formation (early Wuchiapingian); 2018; Ghaderi leg.; illustrated in Fig. 9L–M; MB.C.32002.

Description

Holotype MB.C.31997 is a quarter volution of a phragmocone with a maximum whorl height of 36 mm, meaning that the phragmocone diameter was about 100 mm. It allows the study of three whorls, in which the ontogenetic change of conch geometry and sculpture can be observed (Fig. 9A). While the ww/wh ratio is 0.87 in the penultimate volution, it is reduced to 0.75 in the last volution. Furthermore, the venter shows increased flattening during this growth interval. However, even the last 90 degrees of the phragmocone show some variation; the shape of the venter varies from slightly concave to slightly convex (Fig. 9B–C). The flanks are nearly flat, the umbilical margin is narrowly rounded and the flattened umbilical wall is oblique.

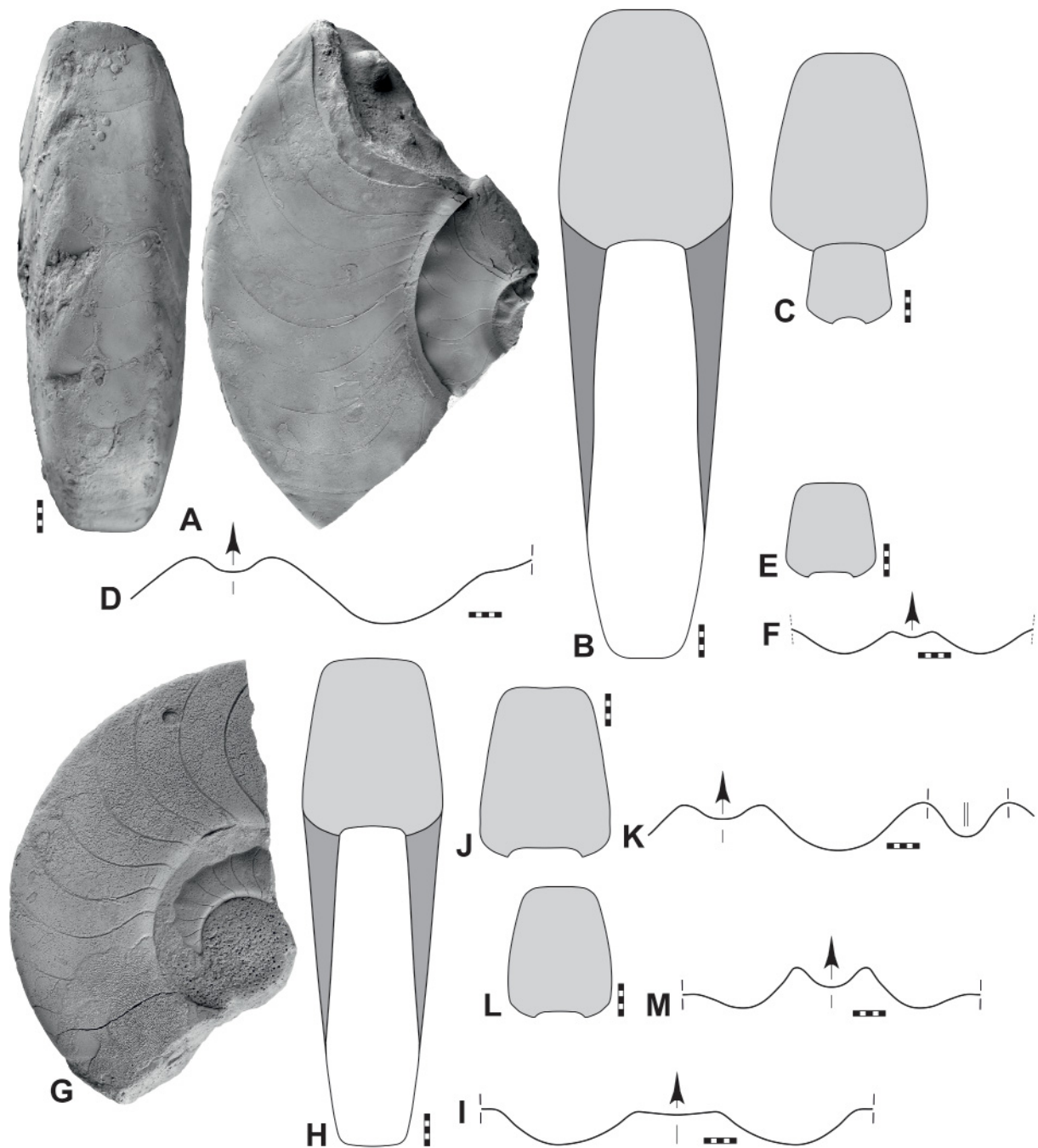

Fig. 9. *Domatoceras multituberculatum* sp. nov. from the *Araxoceras* Beds of the Julfa Formation. **A.** Holotype MB.C.31997 (Korn *et al.* 2011 Coll.) from Aras Valley, ventral and lateral views. **B.** The same specimen, reconstruction of apertural view. **C.** The same specimen, whorl profiles. **D.** The same specimen, suture line at $ww=26.6$ mm, $wh=35.7$ mm. **E.** Paratype MB.C.31999 (Ghaderi 2018 Coll.) from Aras Valley, whorl profile. **F.** The same specimen, suture line at $ww=13.2$ mm, $wh=15.5$ mm. **G.** Paratype MB.C.31998 (Ghaderi 2018 Coll.) from Aras Valley, lateral view. **H.** The same specimen, reconstruction of apertural view. **I.** The same specimen, suture line at $ww=20.1$ mm, $wh=24.3$ mm. **J.** Paratype MB.C.32000 (Ghaderi 2018 Coll.) from Aras Valley, whorl profile. **K.** The same specimen; suture line at $ww=19.5$ mm, $wh=26.3$ mm. **L.** Specimen MB.C.32002 (Ghaderi 2018 Coll.) from Ali Bashi 4, whorl profile. **M.** The same specimen; suture line at $ww=16.1$ mm, $wh=20.0$ mm. Scale bar units=1 mm.

Table 2. Conch dimensions (in mm) and ratios of *Domatoceras multituberculatum* sp. nov.; reconstructed dimensions and ratios in italics.

| Nr. | dm | ww | wh | uw | ah | ww/dm | ww/wh | uw/dm | WER | IZR |
|------------|--------------|------|------|-------------|------|-------|-------|-------------|-------------|------|
| MB.C.31997 | <i>100.9</i> | 27.2 | 37.3 | <i>38.6</i> | 35.6 | 0.27 | 0.73 | <i>0.38</i> | <i>2.39</i> | 0.05 |
| MB.C.31997 | – | 23.8 | 30.3 | – | – | – | 0.79 | – | – | – |
| MB.C.31997 | – | 15.0 | 17.2 | – | – | – | 0.87 | – | – | – |
| MB.C.31998 | <i>75.9</i> | 21.8 | 27.6 | <i>28.5</i> | 26.1 | 0.29 | 0.79 | <i>0.38</i> | <i>2.32</i> | 0.05 |
| MB.C.32000 | – | 20.4 | 26.4 | – | – | – | 0.77 | – | – | – |
| MB.C.32002 | – | 16.3 | 20.1 | – | – | – | 0.81 | – | – | – |
| MB.C.32001 | – | 15.1 | 18.8 | – | – | – | 0.80 | – | – | – |
| MB.C.31999 | – | 13.3 | 15.4 | – | – | – | 0.86 | – | – | – |

There is no sculpture visible on the last whorl, but the two whorls before show shallow and broad ventrolateral tubercles, which in the third-last whorl even shows a prolongation into ribs that are connected with barely visible umbilical nodes. The specimen has rather narrowly standing septa; on the last quarter volution of the phragmocone there are nine septa with a trend to crowding at the end (SD ~10 degrees in average). The terminal suture line has a very shallow external lobe, a broadly rounded lateral lobe and a very shallow, ventrally inclined lobe on the umbilical wall (Fig. 9D).

Paratype MB.C.31998 is, though incomplete, one of the best in the available material (Fig. 9G). It is a fully septate specimen with an estimated diameter of about 73 mm and allows the study of two whorls of the phragmocone. The estimated ww/dm and uw/dm ratios are 0.31 and 0.37, respectively. The whorl profile is weakly compressed (ww/wh=0.79) with a nearly flat venter, a pronounced subangular ventrolateral shoulder and flattened, weakly convergent flanks. The whorls are widest at the narrowly rounded umbilical margin (Fig. 9H).

The last whorl of the phragmocone appears to be free of sculpture, but the penultimate whorl shows rather coarse, low ventrolateral conical nodes, which are arranged in distances of about 15 degrees. The suture line has a very shallow external lobe, a subangular ventrolateral saddle (with a position at the ventrolateral shoulder) and a broadly rounded, shallow lateral lobe. Additionally, a very shallow, small and rounded lobe is visible on the umbilical wall (Fig. 9I). Both the last and the penultimate whorl show six chambers on a quarter of a volution (SD ~15 degrees).

A complete suture line is visible in the fragmentary paratype MB.C.32000. It shows a rather narrow and shallow external lobe, a broadly rounded lateral lobe that has three times the depth of the external lobe. The specimen shows a rather narrow internal lobe of three quarters the depth of the lateral lobe (Fig. 9K). The smaller fragmentary paratypes MB.C.31999 (Fig. 9E–F) and MB.C.32002 (Fig. 9L–M) show the variation of the depth of the external lobe.

Remarks

Domatoceras multituberculatum sp. nov. differs from *D. elegantulum* sp. nov. in the conical ventrolateral nodes of the preadult whorls, the slightly more evolute and stouter conch, the less compressed whorl profile and the narrowly rounded umbilical margin.

Domatoceras multituberculatum sp. nov. differs from *D. convergens* by the less strongly convergent flanks and the much wider whorl profile (ww/wh ~0.80 in contrast to *D. convergens* with ~0.60) at a conch diameter of 75 mm. The venter is much wider in *D. elegantulum* sp. nov. when compared to *D. convergens*.

Domatoceras convergens (Abich, 1878)

Fig. 10

Nautilus convergens Abich, 1878: 17, pl. 3 fig. 2.

Domatoceras convergens – Shimansky 1965a: 41, pl. 15 fig. 9.

Diagnosis

Species of *Domatoceras* with extremely discoidal, subevolute and weakly compressed, inverted trapezoidal whorl profile (ww/wh ~0.60) at a conch diameter of 75 mm. Whorl profile with flat, very narrow venter, subangular ventrolateral shoulder, convergent, flattened flanks and broadly rounded umbilical margin. Suture line with a very narrow and very shallow external lobe and a much larger and deeper, broadly rounded lateral lobe.

Material examined

IRAN – **West Azerbaijan** • 1 specimen; Aras Valley; *Araxoceras* Beds of the Julfa Formation (early Wuchiapingian); 2018; Ghaderi leg.; illustrated in Fig. 10; MB.C.32003 • 1 specimen; same data as for preceding; 2018; Ghaderi leg.; MB.C.32004. – **East Azerbaijan** • 1 specimen; Ali Bashi 4; *Araxoceras* Beds of the Julfa Formation (early Wuchiapingian); 2010; Korn *et al.* leg.; MB.C.32005.

Description

Specimen MB.C.32003 is, though fragmentarily preserved, suitable for identification as it shows some specific characters (Fig. 10A). It has a whorl height of 26 mm and a ww/wh ratio of 0.57. The venter is flat and bordered by an angular ventrolateral shoulder; the flanks are weakly convex and converge from the rounded umbilical margin (Fig. 10B). The suture line shows a small and very shallow external lobe and a very wide, broadly rounded lateral lobe (Fig. 10C).

Remarks

Abich (1878: 17, pl. 3 fig. 2) described and illustrated, as “*Nautilus convergens*, nov. form.”, a fragment (less than a quarter of a volution) of an internal mould of 40 mm whorl height. From this, the conch shape can be reconstructed rather well. The inverted trapezoidal whorl profile is compressed (ww/wh=0.62) and very weakly inflected dorsally by the preceding whorl. It is widest near the umbilical margin. The flanks converge rather rapidly and are separated from the flattened venter by a subangular ventrolateral shoulder. There is a shallow longitudinal groove on the outer portion of the flank just adjacent to the ventrolateral shoulder. No ornament can be seen. The suture line shows a broad rounded lobe on the flank and a very shallow lobe on the venter.

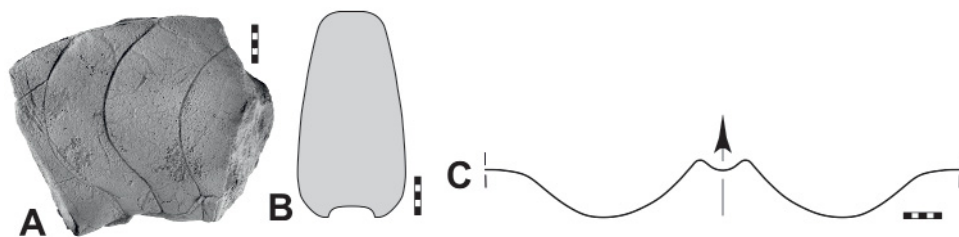

Fig. 10. *Domatoceras convergens* (Abich, 1878), specimen MB.C.32003 (Ghaderi 2018 Coll.) from the *Araxoceras* Beds of the Julfa Formation at Aras Valley. **A.** Lateral view. **B.** Whorl profile. **C.** Suture line at ww=14.5 mm, wh=26.0 mm. Scale bar units=1 mm.

Domatoceras parallelum (Abich, 1878)

Nautilus parallelus Abich, 1878: 17, pl. 2 fig. 2.

Remarks

“*Nautilus parallelus*, nov. form.” was described and illustrated by Abich (1878: 17, pl. 2 fig. 2). This illustration shows a fragment of less than half a volution of a specimen with a conch diameter of about 120 mm. Only the last whorl is preserved and this appears to be deformed or corroded on one side. Therefore, the conch shape cannot be precisely described. However, it can be seen that the umbilicus is rather wide ($uw/dm \sim 0.45$) and that the flanks are almost parallel. Specimens with this morphology have not been collected from NW Iran.

Genus *Permodomatoceras* Ruzhencev & Shimansky, 1954

Type species

Permodomatoceras trapezoidale Ruzhencev & Shimansky, 1954; original designation.

Diagnosis

Genus of the family Domatoceratidae with a subinvolute to subevolute conch. High to extremely high coiling rate; whorl profile weakly compressed or weakly depressed. Venter flattened or weakly concave, flanks usually flattened and slightly convergent; umbilical margin rounded or angular. Without sculpture. Suture line with small and shallow external lobe and broadly rounded lateral lobe; without annular process.

Included species

South Urals (Kruglov 1928; Ruzhencev & Shimansky 1954; Barskov *et al.* 2014): *Domatoceras Fredericksi* Kruglov, 1928, Artinskian, South Urals; *Permodomatoceras trapezoidale* Ruzhencev & Shimansky, 1954, Artinskian; *Permodomatoceras permianum* Barskov & Shilovsky in Barskov *et al.*, 2014, Roadian; *Permodomatoceras marielense* Barskov & Shilovsky in Barskov *et al.*, 2014, Roadian.

Transcaucasia (this paper): *Permodomatoceras hamdii* sp. nov., Wuchiapingian, NW Iran.

Himalayas (Diener 1903): *Nautilus hunicus* Diener, 1903, Wuchiapingian.

Timor (Haniel 1915): *Discites Arthaberi* Haniel, 1915, Kungurian.

Remarks

According to Ruzhencev & Shimansky (1954: 95), *Permodomatoceras* is distinguished from *Domatoceras* by its more angular and lower whorls; the ratio of whorl width to height is between 0.90 and 1.10 in *Permodomatoceras* and only about 0.70 in *Domatoceras*. In addition, the external lobe is less well developed in *Permodomatoceras*. *Permodomatoceras* is thought to be closer to the American genera *Penascoceras* and *Parapenascoceras* in terms of whorl profile, but is clearly distinguished from them by a greater amplitude of suture elements and longer chambers.

Permodomatoceras hamdii sp. nov.

urn:lsid:zoobank.org:act:C3FB68E4-18D0-4B64-946A-75FE355723EA

Fig. 11; Table 3

Domatoceras hunicum – Shimansky 1965b: 161, pl. 15 fig. 12. — Teichert & Kummel 1973: 421, pl. 1 figs 7–8, pl. 2 figs 3–4.

Diagnosis

Species of *Permodomatoceras* with extremely discoidal, subevolute conch (ww/dm \sim 0.30; uw/dm \sim 0.40), weakly compressed whorl profile (ww/wh \sim 0.80) and very high coiling rate (WER \sim 2.45) at a conch diameter of 80 mm. Whorl profile with weakly concave venter, subangular ventrolateral shoulder, gently convergent, flattened flanks and narrowly rounded umbilical margin. Ornament with fine growth lines, without ribs or nodes. Suture line with a narrow and very shallow external lobe and a much larger and deeper, broadly rounded lateral lobe.

Etymology

Named after the late Bahaeddin Hamdi (1935–2019), the promoter of palaeontology in Iran.

Type material

Holotype

IRAN – **East Azerbaijan** • Ali Bashi 4; *Araxoceras* Beds of the Julfa Formation (early Wuchiapingian); 2018; Ghaderi leg.; illustrated in Fig. 11; MB.C.32006.

Paratypes

IRAN – **West Azerbaijan** • 1 specimen; Aras Valley; *Araxoceras* Beds of the Julfa Formation (early Wuchiapingian); 2018; Ghaderi leg.; MB.C.32007 • 1 specimen; same data as for preceding; 2011; Korn *et al.* leg.; MB.C.32008 • 1 specimen; same data as for preceding; 2013; Korn *et al.* leg.; MB.C.32009 • 2 specimens; same data as for preceding; 2018; Korn *et al.* leg.; MB.C.32010 to MB.C.32011. – **East Azerbaijan** • 1 specimen; Ali Bashi 4; *Araxoceras* Beds of the Julfa Formation (early Wuchiapingian); 2018; Ghaderi leg.; MB.C.32012 • 1 specimen; same data as for preceding; 2010; Korn *et al.* leg.; MB.C.32013 • 1 specimen; same data as for preceding; 2011; Korn *et al.* leg.; MB.C.32014 • 1 specimen; Zal; *Araxoceras* Beds of the Julfa Formation (early Wuchiapingian); 2018; Ghaderi leg.; MB.C.32015.

Description

Holotype MB.C.32006 is a phragmocone fragment with a whorl height of 30 mm (Fig. 11A) and allows for examination of the dorsal whorl area. The shape of the conch was reconstructed using this fragment; this results in a diameter of 80 mm. The whorl profile of the specimen is compressed (ww/wh=0.80) and trapezoidal with a very weakly concave venter, subangular ventrolateral shoulders, flattened and convergent flanks, a rounded umbilical margin and a very shallow dorsal zone (Fig. 11B). The dorsal zone shows that the penultimate whorl also had a weakly concave venter. The complete suture line is exposed. It shows that the external lobe is very shallow and that the ventrolateral saddle is subangular. The lateral lobe is broadly rounded and continues, at the umbilical seam, into a very shallow internal

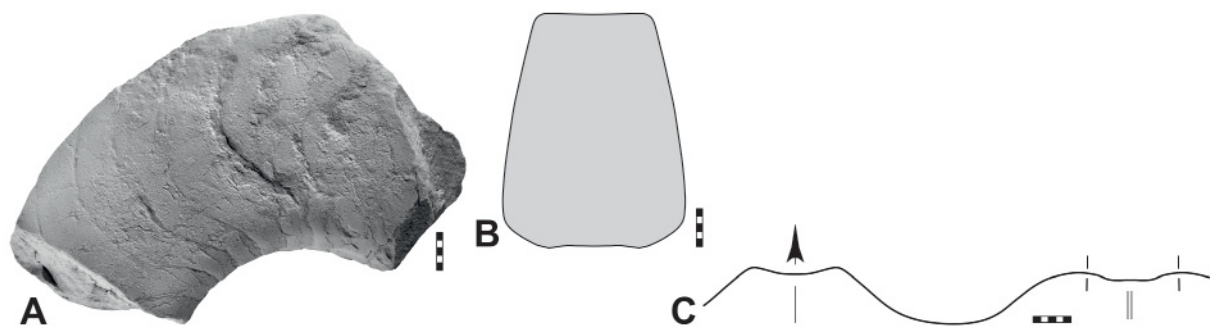

Fig. 11. *Permodomatoceras hamdii* sp. nov., holotype MB.C.32006 (Ghaderi 2018 Coll.) from the *Araxoceras* Beds of the Julfa Formation at Ali Bashi 4. **A.** Lateral view. **B.** Whorl profile. **C.** Suture line at ww=23.3 mm, wh=27.6 mm. Scale bar units = mm.

Table 3. Conch dimensions (in mm) and ratios of *Permodomatoceras hamdii* sp. nov.; reconstructed dimensions and ratios in italics.

| Nr. | dm | ww | wh | uw | ah | ww/dm | ww/wh | uw/dm | WER | IZR |
|------------|-------------|------|------|-------------|------|-------------|-------|-------------|-------------|------|
| MB.C.32006 | <i>80.0</i> | 24.4 | 30.5 | <i>31.0</i> | 29.0 | <i>0.31</i> | 0.80 | <i>0.39</i> | <i>2.46</i> | 0.05 |
| MB.C.32009 | – | 30.6 | 35.3 | – | – | – | 0.87 | – | – | – |
| MB.C.32010 | – | 28.0 | 35.0 | – | – | – | 0.80 | – | – | – |
| MB.C.32015 | – | 29.5 | 33.3 | – | – | – | 0.89 | – | – | – |
| MB.C.32007 | – | 25.5 | 28.6 | – | – | – | 0.89 | – | – | – |
| MB.C.32013 | – | 21.8 | 25.4 | – | – | – | 0.86 | – | – | – |

lobe, in which a very low and rounded saddle is raised (Fig. 11C). The septa are closely spaced; there are about ten chambers on a quarter of a volution (SD ~9 degrees).

Some of the other specimens, such as paratype MB.C.32015, which is not illustrated, show a transformation of the ventrolateral shoulder from a subangular to a tightly rounded shape in the adult stage. In this specimen the shape change takes place at about 28 mm whorl height.

Remarks

It is most likely that the specimens illustrated by Shimansky (1965b) and Teichert & Kummel (1973) under the name “*Domatoceras hunicum*” belong to this species. However, *P. hunicum* differs from the new species in having septa in much larger distances (about five septa per quarter volution) than *P. hamdii* sp. nov. (10 septa per quarter volution). Another difference is the rate on whorl overlap, which is rather great in *P. hunicum* (IZR ~0.15), while it is very low in *P. hamdii* (IZR ~0.05).

The new species has a narrower whorl profile (ww/wh=0.80) than the type species of the genus. However, as its conch shape with the almost rectangular, rather wide whorl profile clearly distinguishes it from the species of the genus *Domatoceras*, it is classified here as *Permodomatoceras*.

Genus *Fididomatoceras* gen. nov.

urn:lsid:zoobank.org:act:FE3F69BC-FA94-4E56-9253-D9583FCD3BB2

New genus A – Korn 2025: 39.

Type species

Fididomatoceras intracostatum gen. et sp. nov.

Diagnosis

Genus of the family Domatoceratidae with a small to moderately large, subinvolute conch; whorl profile lyriform, venter flat or concave and bordered by raised keels, umbilical margin narrowly rounded. Sculpture missing or with blunt ribs on the flanks in the juvenile stage. Suture line with narrow, rounded external lobe and broadly rounded lateral lobe.

Etymology

Combination of the Latin ‘*fidis*’ (noun, f.)= ‘lyre’ and *Domatoceras*; because of the lyriform whorl profile.

Included species

Transcaucasia (Shimansky 1965b; this paper): *Fididomatoceras gracile* (Shimansky, 1965) gen. et comb. nov., Wuchiapingian, Azerbaijan; *Fididomatoceras intracostatum* gen. et sp. nov., Wuchiapingian, NW Iran.

Remarks

The new genus differs from most other genera in the family Domatoceratidae by its narrow umbilicus ($uw/dm=0.25-0.30$), which in the other genera is usually much wider ($uw/dm=0.35-0.40$). The most important distinguishing feature, however, is the shape of the ventrolateral shoulder, which in the other genera is tightly rounded or simply subangular or angular, but in *Fididomatoceras* gen. nov. is accentuated by a shallow inflexion of the outer flank. The lyriform whorl profile in *Fididomatoceras* is also the main difference to the otherwise similar Late Carboniferous genus *Stenodomatoceras*.

Fididomatoceras gracile (Shimansky, 1965) gen. et comb. nov.
Fig. 12; Table 4

Domatoceras gracile Shimansky, 1965b: 160, pl. 16 fig. 1.

Diagnosis

Species of *Fididomatoceras* gen. nov. with thinly discoidal, subinvolute conch ($ww/dm \sim 0.35$; $uw/dm \sim 0.25$), weakly compressed whorl profile ($ww/wh \sim 0.70$) and extremely high coiling rate ($WER \sim 3.05$) at a conch diameter of 40–55 mm. Whorl profile inverted trapezoidal with convergent flanks; venter and flanks flattened, umbilical margin broadly rounded. Suture line with broadly rounded, moderately deep external lobe and slightly larger and deeper, broadly rounded lateral lobe.

Type material

Holotype

AZERBAIJAN • Dorasham 1; *Araxoceras* Beds of the Julfa Formation (early Wuchiapingian); illustrated by Shimansky (1965b: pl. 16 fig. 1); PIN 1572/211.

Material examined

IRAN – East Azerbaijan • 1 specimen; Ali Bashi N; *Araxoceras* Beds of the Julfa Formation (early Wuchiapingian); 2018; Korn *et al.* leg.; illustrated in Fig. 12; MB.C.32016.

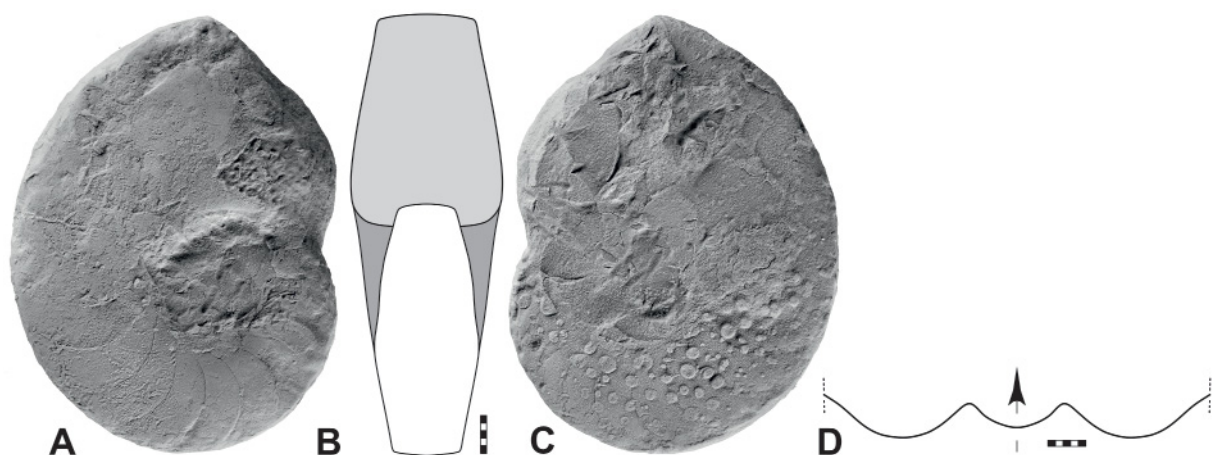

Fig. 12. *Fididomatoceras gracile* (Shimansky, 1965) gen. et comb. nov., specimen MB.C.32016 (Korn *et al.* 2018 Coll.) from the *Araxoceras* Beds of the Julfa Formation at Ali Bashi N. **A.** Lateral view of left side. **B.** Reconstruction of apertural view. **C.** Lateral view of right side. **D.** Suture line at $dm=58.0$ mm, $ww=17.0$ mm, $wh=21.0$ mm. Scale bar units = 1 mm.

Table 4. Conch dimensions (in mm) and ratios of *Fididomatoceras gracile* Shimansky, 1965 gen. et comb. nov.

| Nr. | dm | ww | wh | uw | ah | ww/dm | ww/wh | uw/dm | WER | IZR |
|--------------|------|------|------|------|------|-------|-------|-------|------|------|
| MB.C.32016 | 58.4 | 20.5 | 29.2 | 15.4 | 25.0 | 0.35 | 0.70 | 0.26 | 3.06 | 0.14 |
| PIN 1572/211 | 40.0 | 15.0 | 20.5 | 10.0 | 17.0 | 0.38 | 0.73 | 0.25 | 3.02 | 0.17 |

Description

Specimen MB.C.32016 is a fairly complete, but rather poorly preserved specimen with a conch diameter of 58 mm (Fig. 12A, C). On the right side it is heavily encrusted by a tabular coral colony. The conch is thinly discoidal and subinvolute ($ww/dm=0.35$; $uw/dm=0.26$) with a compressed whorl profile ($ww/wh=0.70$). The venter is weakly flattened and bordered by a subangular ventrolateral shoulder. The umbilical margin is rounded, from here the sinuous flanks converge to the venter (Fig. 12B). The suture line has a relatively large and deep, broadly rounded external lobe, a narrowly rounded ventrolateral saddle and a broadly rounded, shallow lateral lobe that occupies the entire flank (Fig. 12D).

Remarks

Shimansky (1965b) discussed the external similarity of *Fididomatoceras gracile* gen. et comb. nov. and the Late Carboniferous species *Stenodomatoceras moorei* (Miller, Dunbar & Condra, 1933). He stated that differences between these species mainly regard very different conch sizes and the much more involute conch of *S. moorei*. He thus regarded this as a case of homeomorphy. However, the size of the specimens can hardly be used to distinguish species or even genera. The holotype of *F. gracile* is only 40 mm in diameter and is probably a preadult specimen. The difference in umbilical width is a better separating criterion; the holotype of *S. moorei* has, at a conch diameter of 40 mm, a uw/dm ratio of 0.21, whereas this is 0.28 in the holotype of *F. gracile*.

A hypothetical criterion for differentiation between *Fididomatoceras* gen. nov. and *Stenodomatoceras* could be the position of the siphuncle; this is close to the venter in *S. moorei* and also in *S. kleihegei* (Miller, Lane & Unklesbay, 1947). However, the position of the siphuncle in *F. gracile* gen. et comb. nov. is not known. *Stenodomatoceras kleihegei* and *S. gardi* (Murphy, 1970) possess a concave venter bordered by a slightly raised ventrolateral shoulder, which is narrowly rounded or subangular in *F. gracile*. Because of these differences, but mainly because of the large stratigraphic distance in occurrence of the three known Late Carboniferous North American species of *Stenodomatoceras* and *F. gracile*, we follow the interpretation of Shimansky (1965b) here and do not classify *F. gracile* in *Stenodomatoceras*. Instead, we place it in the new genus *Fididomatoceras* described here.

Fididomatoceras gracile gen. et comb. nov. can be easily distinguished from most of the species of the family Domatoceratidae from Transcaucasia by the narrower umbilicus, the more widely embracing whorls and the higher coiling rate ($WER > 3.00$ in *F. gracile*, but usually 2.25–2.50 in the other species). *Fididomatoceras gracile* differs from *F. intracostatum* gen. et sp. nov. in the absence of ribs in the juvenile stage and in the less distinct ventrolateral shoulder, which is narrowly rounded in *F. gracile* but angular in *F. intracostatum*. Furthermore, *F. gracile* has a higher coiling rate ($WER > 3.00$) than *F. intracostatum* ($WER < 2.75$).

Fididomatoceras intracostatum gen. et sp. nov.

urn:lsid:zoobank.org:act:3DDD3943-57AC-4E12-9036-70812D1C1220

Fig. 13; Table 5

Diagnosis

Species of *Fididomatoceras* gen. nov. with thinly discoidal, subinvolute conch ($ww/dm \sim 0.40$; $uw/dm \sim 0.27$), weakly compressed whorl profile ($ww/wh \sim 0.90$) and extremely high coiling rate

(WER ~ 2.55) at a conch diameter of 30 mm. Whorl profile inverted trapezoidal or lyriform with convergent flanks; venter flattened, flanks flattened or slightly concave in the outer area, umbilical margin narrowly rounded. Sculpture in the juvenile stage with blunt ribs on the flanks. Suture line with very narrow external lobe and slightly larger and deeper, broadly rounded lateral lobe.

Etymology

Combination of the Latin ‘*intra*’ (prepos.)=‘inner’ and ‘*costatum*’ (adj., n.)=‘ribbed’; because of the juvenile sculpture.

Type material

Holotype

IRAN – **East Azerbaijan** • Ali Bashi N; *Araxoceras* Beds of the Julfa Formation (early Wuchiapingian); 2018; Korn *et al.* leg.; illustrated in Fig. 13A–B; MB.C.32017.

Paratype

IRAN – **West Azerbaijan** • 1 specimen; Aras Valley; *Araxoceras* Beds of the Julfa Formation (early Wuchiapingian); 2018; Ghaderi leg.; illustrated in Fig. 13C–E; MB.C.32018.

Description

Holotype MB.C.32017 is the better preserved of the two comparatively small specimens (Fig. 13A). It has a conch diameter of 32 mm and is thinly discoidal and subinvolute ($ww/dm=0.42$; $uw/dm=0.26$). The coiling rate is extremely high (WER=2.61) and the imprint zone is small. The whorl profile is weakly compressed ($ww/wh=0.89$) and shows a narrowly rounded umbilical margin and a steep, slightly flattened umbilical wall. The conch is widest near the umbilical margin; from here the flanks slowly converge towards the angular ventrolateral shoulder, which is preserved as a weakly elevated ridge. The venter becomes flat only in the last half of the volution, beginning at a conch diameter of about 22 mm. Before this, the venter is broadly rounded (Fig. 13B). Shell remains are visible on large areas of the specimen, they show periodically strengthened growth lines extending with a broad arch in backward direction across the flanks and form a deep, angular ventral sinus. Two thirds of the last volution belong to this stage, while the previous ontogenetic stage before possesses shallow, backwardly directed ribs on the flanks.

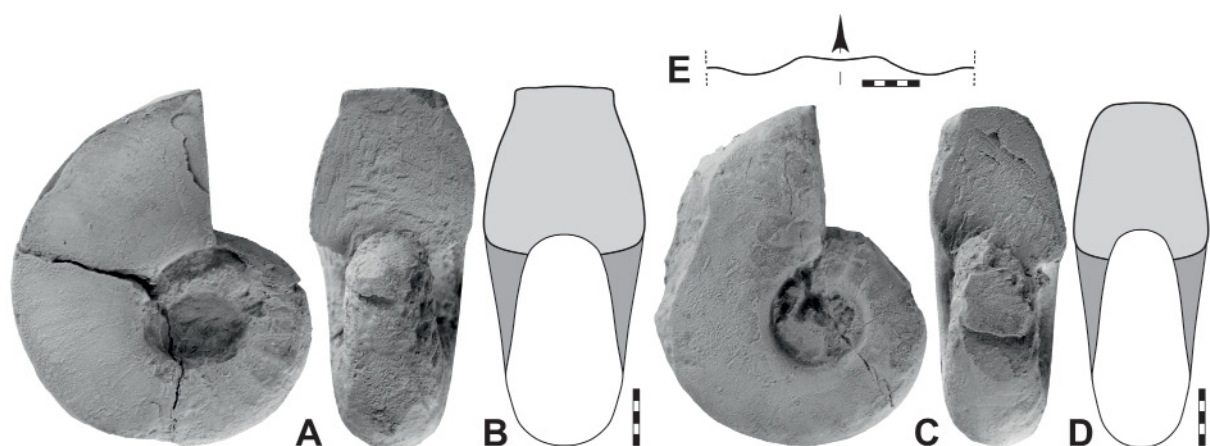

Fig. 13. *Fididomatoceras intracostatum* gen. et sp. nov. **A.** Holotype MB.C.32017 (Korn *et al.* 2018 Coll.) from the *Araxoceras* Beds of the Julfa Formation at Ali Bashi N, lateral and apertural views. **B.** The same specimen, reconstruction of apertural view. **C.** Paratype MB.C.32018 (Ghaderi 2018 Coll.) from Aras Valley, lateral and apertural views. **D.** The same specimen, reconstruction of apertural view. **E.** The same specimen; suture line at $ww=8.4$ mm, $wh=7.0$ mm. Scale bar units = mm.

Table 5. Conch dimensions (in mm) and ratios of *Fididomatoceras intracostatum* gen. et sp. nov.

| Nr. | dm | ww | wh | uw | ah | ww/dm | ww/wh | uw/dm | WER | IZR |
|------------|------|------|------|-----|------|-------|-------|-------|------|------|
| MB.C.32017 | 32.0 | 13.3 | 15.0 | 8.4 | 12.2 | 0.42 | 0.89 | 0.26 | 2.61 | 0.19 |
| MB.C.32018 | 30.3 | 11.7 | 13.5 | 9.0 | 11.2 | 0.39 | 0.87 | 0.30 | 2.52 | 0.17 |

Paratype MB.C.32018 has a conch diameter of 31 mm (Fig. 13C). It is thinly discoidal and subinvolute ($ww/dm=0.39$; $uw/dm=0.30$) with a compressed whorl profile ($ww/wh=0.87$). The venter is rounded up to a conch diameter of 27 mm and becomes flattened thereafter (Fig. 13D). This means that it reaches the stage with pronounced ventrolateral shoulders and the appanate venter at a larger conch diameter than the holotype. The suture line shows a very shallow, broadly rounded external lobe and a slightly deeper, rounded lateral lobe (Fig. 13E).

Remarks

Fididomatoceras intracostatum gen. et sp. nov. can hardly be confused with another nautilid species of Transcaucasia because of its very characteristic morphology. *Fididomatoceras intracostatum* differs from *F. gracile* gen. et comb. nov. in the presence of ribs in the juvenile stage and in the more distinct ventrolateral shoulder, which is angular in *F. intracostatum* but narrowly rounded in *F. gracile*. Furthermore, *F. intracostatum* has a lower coiling rate ($WER < 2.75$) than *F. gracile* ($WER > 3.00$).

New family Korn & Hairapetian (in press)

Diagnosis

Family of the superfamily Grypoceratoidea with a usually discoidal, subinvolute conch. Whorl profile in the adult stage weakly compressed or weakly depressed; flanks and venter usually separated by a distinct ventrolateral shoulder, venter more or less concave. Umbilical margin usually subangular or angular, rarely rounded; umbilical wall steep, often flattened. Ornament usually consisting of fine growth lines. Septum simple in shape, concavely domed; suture line depending on whorl profile with shallow to V-shaped external lobe and shallow lateral lobe (from Korn & Hairapetian in press: 14).

Included genera

Pseudotitanoceras Shimansky, 1965 (Permian); new genus A to be described by Korn & Hairapetian (in press) (Permian); new genus B to be described by Korn & Hairapetian (in press) (Permian); *Azarinautilus* gen. nov. (Permian).

Remarks

A detailed discussion of the new family will be given by Korn & Hairapetian (in press).

Genus *Azarinautilus* gen. nov.

urn:lsid:zoobank.org:act:CD71EEC0-54D7-47EC-A234-F505CEDED059

New genus B – Korn 2025: 43.

Type species

Azarinautilus nahidae gen. et sp. nov.

Diagnosis

Genus of the new family Korn & Hairapetian (in press) with a rather small, subinvolute or subevolute conch; whorl profile lyriform, venter moderately to deeply concave and bordered by raised keels,

umbilical margin broadly rounded or subangular. Sculpture with conical nodes or shallow ribs in the midflank area. Suture line with narrow, rounded external lobe and broadly rounded lateral lobe.

Etymology

Combination of the name of the type region in East Azerbaijan and *Nautilus*.

Included species

NW Iran (this paper): *Azarinautilus nahidae* gen. et sp. nov., Wuchiapingian.

Central Iran (Korn & Hairapetian in press): new species D to be described by Korn & Hairapetian (in press), Changhsingian.

Remarks

The new genus has an isolated position within the new family to be described by Korn & Hairapetian (in press) because of its conch shape and sculpture. A comparably distinctly concave venter has apparently not been described from any other genus of the family; however, species of *Fididomatoceras* gen. nov. show a flat or slightly concave venter bordered laterally by low ridges.

Azarinautilus gen. nov. differs from the other genera of the new family to be described by Korn & Hairapetian (in press) in the size of the conchs. Specimens of *Azarinautilus* may reach a conch diameter of about 50 mm, while species of the other genera reach 100 mm or more. Another difference lies in the sculpture of the conchs: *Azarinautilus* possesses lateral ribs, which are absent in most other species of the family.

Azarinautilus nahidae gen. et sp. nov.

urn:lsid:zoobank.org:act:7D491B43-BAEB-43BB-851F-9655D2549ADB

Fig. 14; Table 6

Diagnosis

Species of *Azarinautilus* gen. nov. with thickly discoidal, subinvolute conch ($ww/dm \sim 0.47$; $uw/dm \sim 0.27$), weakly depressed whorl profile ($ww/wh \sim 1.00$ – 1.25) and very high to extremely high coiling rate ($WER = 2.30$ – 2.60) at a conch diameter of 25–35 mm. Whorl profile weakly lyriform with strongly convergent, broadly convex flanks; venter deeply concave, umbilical margin broadly rounded. Sculpture with conical nodes in the midflank area. Suture line with rounded, broadly V-shaped external lobe and broadly rounded lateral lobe.

Etymology

Named after Nahideh Ghanizadeh Tabrizi, who assisted in the 2018 field session.

Type material

Holotype

IRAN – **East Azerbaijan** • Ali Bashi 4; *Araxoceras* Beds of the Julfa Formation (early Wuchiapingian); 2010; Korn *et al.* leg.; illustrated in Fig. 14A–B; MB.C.32019.

Paratypes

IRAN – **East Azerbaijan** • 1 specimen; Ali Bashi 4; *Araxoceras* Beds of the Julfa Formation; 2018; Ghaderi leg.; illustrated in Fig. 14C–E; MB.C.32020 • 2 specimens; Ali Bashi 4; *Araxoceras* Beds of the Julfa Formation; 2018; Ghaderi leg.; MB.C.32021 to MB.C.32022.

Description

Holotype MB.C.32019 is a fragmentary internal mould specimen with a conch diameter of 30 mm (Fig. 14A). It is thickly discoidal and subinvolute ($ww/dm=0.47$; $uw/dm=0.27$) with a whorl width equal to the whorl height. The lyriform whorl profile is widest at the broadly rounded umbilical margin, from where the flanks rapidly converge with a slightly concave incurve towards the sharp ventrolateral shoulder; the venter is concave (Fig. 14B). The sculpture consists of blunt conical nodes on the midflank, about eight of them occur in half a volution. Some of these nodes are slightly elongated in direction to the umbilicus. On the ventrolateral margin, there occur barely visible, faint tubercles.

Paratype MB.C.32020 is a fragment of a specimen with a conch diameter of 26 mm. It is fully chambered and preserved as an internal mould (Fig. 14C). The dimensions of the conch have been partially reconstructed, but the general morphology of the conch seems to correspond to the holotype. The ventrolateral shoulder is slightly elevated and forms skid-like ridges bordering the concave venter (Fig. 14D). The suture line forms a rather deep, bluntly rounded external lobe with nearly rectangularly arranged flanks, the ventrolateral saddle is narrowly rounded. The shape of the lateral lobe is generally broadly rounded, but when the septum lies near a conical node, it may show an inflexion (Fig. 14E).

The larger, unillustrated paratype MB.C.32021 shows, with a conch diameter of about 35 mm, an elongation of the midflank ribs; in this specimen these ribs extend almost across the entire flanks.

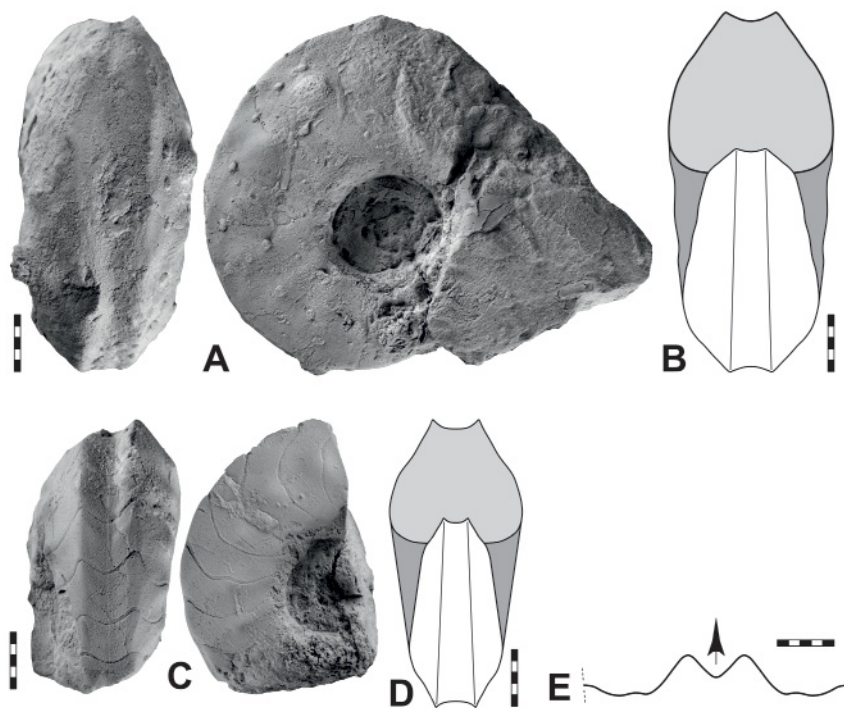

Fig. 14. *Azarinautilus nahidae* gen. et sp. nov. **A.** Holotype MB.C.32019 (Korn *et al.* 2010 Coll.) from the *Araxoceras* Beds of the Julfa Formation at Ali Bashi 4, ventral and lateral views. **B.** The same specimen; reconstruction of apertural view. **C.** Paratype MB.C.32020 (Ghaderi 2018 Coll.) from the *Araxoceras* Beds of the Julfa Formation at Ali Bashi 4, ventral and lateral views. **D.** The same specimen, reconstruction of apertural view. **E.** The same specimen, suture line at $ww=12.0$ mm, $wh=11.1$ mm. Scale bar units=1 mm.

Table 6. Conch dimensions (in mm) and ratios of *Azarinautilus nahidae* gen. et sp. nov.; reconstructed dimensions and ratios in italics.

| Nr. | dm | ww | wh | uw | ah | ww/dm | ww/wh | uw/dm | WER | IZR |
|------------|------|------|------|-----|------|-------|-------|-------|------|------|
| MB.C.32022 | 36.7 | 17.4 | 15.3 | 9.7 | 13.6 | 0.47 | 1.14 | 0.26 | 2.52 | 0.11 |
| MB.C.32019 | 30.6 | 14.5 | 14.4 | 8.4 | – | 0.47 | 1.01 | 0.27 | – | – |
| MB.C.32020 | 26.4 | 12.2 | 10.0 | 7.2 | 9.0 | 0.46 | 1.22 | 0.27 | 2.30 | 0.10 |

Remarks

Although there are only a few specimens available for examination, it can be assumed that this is a species with a small conch. No material is known from which the new species described here could be considered a possible juvenile form. The peculiar morphology with the deeply concave venter, the sharp ventrolateral keels and the conical nodes on the midflank easily distinguish the new species from all other Wuchiapingian species of Transcaucasia.

New genus A Korn & Hairapetian (in press)

Type species

New species E to be described by Korn & Hairapetian (in press); original designation.

Diagnosis

Genus of the new family to be described by Korn & Hairapetian (in press) with a subinvolute conch. Extremely to extraordinarily high coiling rate; whorl profile inverted trapezoidal, weakly compressed or weakly depressed with concave or flat venter and flattened, convergent flanks. Sculpture in the adult stage absent; in the juvenile stage sometimes with short ribs on the flank. Suture line with a shallow to deep V-shaped external lobe and a broadly rounded lateral lobe (from Korn & Hairapetian in press).

Included species

Central Iran (Korn & Hairapetian in press): new species E to be described by Korn & Hairapetian (in press), Wuchiapingian; new species F to be described by Korn & Hairapetian (in press), Wuchiapingian; new species G to be described by Korn & Hairapetian (in press), Wuchiapingian.

Remarks

According to Korn & Hairapetian (in press), the new genus A can hardly be confused with any other genus of Late Permian nautilids because of its very characteristic conch shape. The rather sharp umbilical margin, the flattened and rapidly converging flanks, the angular, skid-like ventrolateral shoulder and the more or less clearly concave venter allow a clear separation. *Pseudotitanoceras* is similar, but this genus is distinguished from the new genus by the presence of tubercles on the ventrolateral shoulder. Shimansky (1965b) mentioned that among his material of *P. armeniacum* there were also specimens without ventrolateral tubercles. Perhaps these do belong to the new genus rather than *Pseudotitanoceras*.

New genus A Korn & Hairapetian (in press) sp.

Fig. 15; Table 7

Material examined

IRAN – **West Azerbaijan** • 1 specimen; Aras Valley; Zal Member of the Ali Bashi Formation (early Changhsingian); 2018; Ghaderi leg.; illustrated in Fig. 15; MB.C.32023 • 1 specimen; same data as for preceding; MB.C.32024.

Table 7. Reconstructed conch dimensions (in mm) and ratios of the new genus A Korn & Hairapetian (in press) sp.

| Nr. | dm | ww | wh | uw | ah | ww/dm | ww/wh | uw/dm | WER | IZR |
|------------|------|------|------|------|------|-------|-------|-------|------|------|
| MB.C.32023 | 71.5 | 30.5 | 37.0 | 13.5 | 27.0 | 0.43 | 0.82 | 0.19 | 2.58 | 0.27 |

Description

Both specimens are fragmentary and only allow the geometry of the conch to be studied. Both have been sectioned and show that the inner whorls are largely crushed and partially dissolved. With a diameter of 72 mm, specimen MB.C.32023 is the smaller of the two (Fig. 15). The reconstruction shows a thinly discoidal, subinvolute conch ($ww/dm=0.43$; $uw/dm=0.19$) with an inverted trapezoidal whorl profile. The venter is concave and bordered by a skid-like sharpened ventrolateral shoulder. The convergent flanks are almost flat with a slightly concave outer region; the umbilical margin is angular and the umbilical wall is flattened and ventrally directed. The surface of the shell appears smooth; the internal form shows no sculpture.

The second specimen MB.C.32024 has a conch diameter of approximately 120 mm and is more strongly deformed and dissolved. It agrees with the smaller specimen in terms of the sharp-edged shape of the umbilical margin.

Remarks

The two specimens from the Aras Valley appear to be very similar to the type species from central Iran in terms of the proportions of the venter. However, there seems to be a difference in the arrangement of the umbilical wall, which is vertical in the type species, but oriented towards the venter in the specimens from NW Iran.

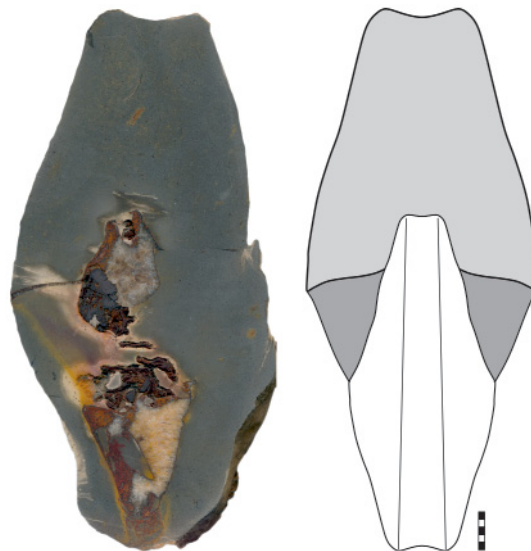
**Fig. 15.** New genus A Korn & Hairapetian (in press) sp., specimen MB.C.32023 (Ghaderi 2018 Coll.) from the Zal Member of the Ali Bashi Formation at Aras Valley, polished cross section and reconstructed apertural view. Scale bar units = 1 mm.

New genus B Korn & Hairapetian (in press)

Diagnosis

Genus of the new family to be described by Korn & Hairapetian (in press) with a subinvolute conch. High coiling rate; whorl profile rounded rectangular, weakly depressed with concave venter. Without sculpture. Suture line with shallow external lobe and broadly rounded lateral lobe; without annular process (from Korn & Hairapetian in press).

Type species

New species H to be described by Korn & Hairapetian (in press); original designation.

Included species

NW Iran (this paper): new genus B to be described by Korn & Hairapetian (in press) *hebes* sp. nov., Wuchiapingian.

Central Iran (Korn & Hairapetian in press): new species H to be described by Korn & Hairapetian (in press), Wuchiapingian.

Remarks

According to Korn & Hairapetian (in press), the new genus B is difficult to confuse with any other genus of Palaeozoic nautiloids because of its peculiar conch morphology with the box-shaped whorl profile, concave venter, skid-like ventrolateral shoulder, subparallel flanks and flattened umbilical wall. The new genus A to be described by Korn & Hairapetian (in press) differs from the new genus B to be described by Korn & Hairapetian (in press) by its clearly convergent flanks, resulting in a much narrower venter; it has an angular ventrolateral shoulder and an angular umbilical margin. *Pseudotitanoceras* also has convergent flanks and is characterised by a row of nodes on the ventrolateral shoulder and sometimes also at the umbilical margin (Shimansky 1965b: 163).

New genus B *hebes* sp. nov.

urn:lsid:zoobank.org:act:D48B5222-AC60-4A5D-8D12-2ECA16FF7865

Fig. 16; Table 8

Diagnosis

Species of *Aifinautilus* with thickly discoidal, subinvolute conch (ww/dm ~0.50; uw/dm ~0.20), equidimensional whorl profile (ww/wh ~1.00) and extremely high coiling rate (WER ~2.70) at a conch diameter of 55 mm. Whorl profile with weakly concave venter, broadly rounded ventrolateral shoulder, weakly convergent flanks, rounded umbilical wall and moderately deep imprint zone (IZR ~0.25). Without sculpture. Suture line with very shallow external lobe and shallow lateral lobe.

Etymology

From the Latin ‘*hebes*’ (adj. m.)=‘blunt’; because of the rounded ventrolateral shoulder and umbilical margin.

Type material

Holotype

IRAN – **East Azerbaijan** • Zal; *Araxoceras* Beds of the Julfa Formation (early Wuchiapingian); 2018; Ghaderi leg.; illustrated in Fig. 16; MB.C.32024.

Table 8. Conch dimensions (in mm) and ratios of *Aifinautilus hebes* sp. nov.

| Nr. | dm | ww | wh | uw | ah | ww/dm | ww/wh | uw/dm | WER | IZR |
|------------|-----|------|------|------|------|-------|-------|-------|------|------|
| MB.C.32024 | 560 | 29.0 | 29.5 | 10.5 | 22.0 | 0.52 | 0.98 | 0.19 | 2.71 | 0.25 |

Description

Holotype MB.C.32024 is an incomplete and laterally slightly distorted, fully chambered specimen with a conch diameter of 55 mm (Fig. 16A). The conch is thickly discoidal and subinvolute ($ww/dm=0.52$; $uw/dm=0.25$) with an extremely high coiling rate ($WER=2.71$) and moderately wide whorl overlap ($IZR=0.25$). The whorl profile is nearly equidimensional ($ww/wh=0.98$) with a weakly concave venter that is bordered by a broadly rounded ventrolateral shoulder; the flanks are broadly convex and weakly convergent (Fig. 16B). The umbilical margin is broadly rounded and the umbilical wall is steep and convex.

The suture line has a shallow external lobe, a narrowly rounded, very high ventrolateral saddle and a broadly rounded lateral lobe (Fig. 16C). The phragmocone has about ten chambers per half revolution.

Remarks

Aifinautilus hebes sp. nov. differs from *A. icanus* in having a much more rounded umbilical margin and ventrolateral shoulder. In addition, the venter of *A. icanus* is much more deeply concave. The suture line of *A. hebes* has a much higher ventrolateral saddle than that of *A. icanus*.

The conch of *A. hebes* sp. nov. shows certain similarities with members of the family Tainoceratidae. The major difference, of course, is the presence of rows of nodes in the Tainoceratidae.

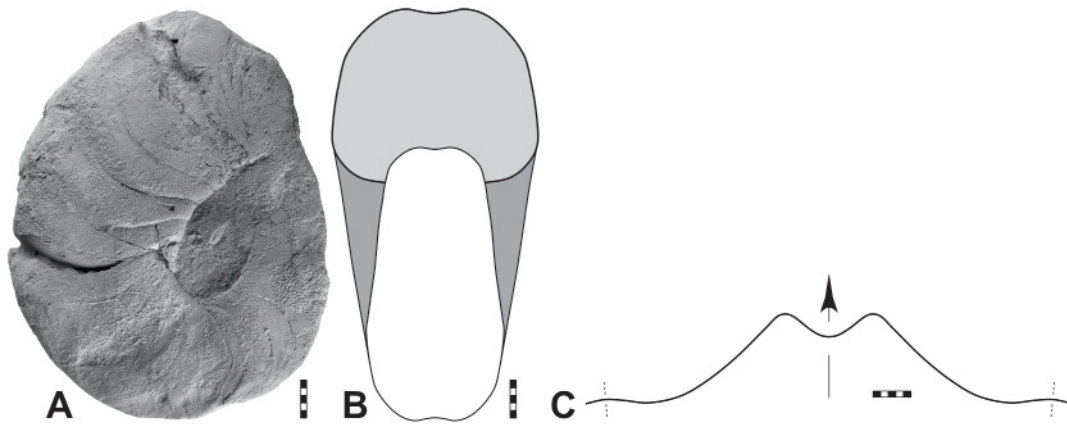

Fig. 16. *Aifinautilus hebes* sp. nov., holotype MB.C.32024 (Ghaderi 2018 Coll.) from the *Araxoceras* Beds of the Julfa Formation at Zal. **A.** Lateral view. **B.** Reconstruction of apertural view. **C.** Suture line at $ww=55.0$ mm, $ww=28.5$ mm, $wh=26.5$ mm. Scale bar units = 1 mm.

Genus *Pseudotitanoceras* Shimansky, 1965

Type species

Nautilus armeniacus Abich, 1878; original designation.

Included species

Nautilus armeniacus Abich, 1878, Wuchiapingian, Azerbaijan.

Remarks

The type species of the genus is rather poorly known. Although there has been a brief revision by Shimansky (1965b) on the basis of new material, there is still no clear differentiation from other species. Shimansky (1965b) discussed the variation in the sculpture of his specimens; however, this may be due to the possibility that he also included specimens of the new genus A to be described by Korn & Hairapetian (in press).

Pseudotitanoceras armeniacum (Abich, 1878)

Nautilus armeniacus Abich, 1878: 24, pl. 2 fig. 5.

Pseudotitanoceras armeniacum – Shimansky 1965b: 162, pl. 16 figs 5–6.

Type material

Holotype

AZERBAIJAN • Dorasham 1; *Araxoceras* Beds (early Wuchiapingian); illustrated by Abich (1878: pl. 2 fig. 5); LGI 14/99.

Remarks

“*Nautilus armeniacus*, nov. form.” was described and illustrated by Abich (1878: pl. 2 fig. 5). It is a phragmocone fragment with a whorl height of about 38 mm. It is deformed but shows some features of the conch shape and sculpture. According to Abich’s description, the flanks are slightly concave and the venter is more clearly concave; they are separated by a narrowly rounded ventrolateral shoulder. The ventrolateral shoulder bears closely spaced nodes, which have the same width as the interspaces and also correspond approximately to the distances between the septa. The suture line shows broadly rounded lobes on the flanks and venter.

Suborder **Tainoceratina** Shimansky, 1957

Diagnosis

Suborder of the order Nautilida, in which a ventrolateral shoulder and an umbilical margin are formed early in ontogeny in the advanced species. Conch usually discoidal, subinvolute to evolute. Juvenile whorl profile depressed oval or circular. Adult whorl profile depressed oval or reniform in the early species, showing numerous modifications during evolution (inverted trapezoidal, trapezoidal or polygonal whorl profiles or with ventral depression). Dorsal whorl zone always present, but usually very small. Juvenile sculpture with radial ribs on the flank; adult sculpture with radial ribs on the flank, ventrolateral nodes or several rows of nodes in derived species. Septa simply domed; with dorsal inflexion in advanced species. Suture line depending on the whorl profile, with shallow lobes and low saddles (from Korn 2025).

Included superfamilies

Tainoceratoidea Hyatt, 1883 (Carboniferous to Triassic); Pleuronautiloidea Hyatt, 1900 (Carboniferous to Triassic).

Remarks

A detailed discussion of the suborder Tainoceratina has been given by Korn (2025).

Superfamily **Pleuronautiloidea** Hyatt, 1900

Diagnosis

Superfamily of the suborder Tainoceratina with a discoidal, subinvolute to subevolute conch. Whorl profile in early species subquadrate with distinct ventrolateral shoulder and distinct umbilical margin. Derived species show a variation of modifications including trapezoidal, inverted trapezoidal or hexagonal whorl profiles with a less angular ventrolateral shoulder and umbilical margin. Whorl overlap is always very small. Sculpture in early species with transverse ribs and ventrolateral nodes, in derived species often with ribs and several rows of nodes. Septa simply domed, in derived species with dorsal inflexion that produces an annular process. Suture line with broadly rounded lateral lobe and shallow lobe or low saddle on the venter (from Korn 2025).

Included families

Pleuronautilidae Hyatt, 1900 (Permian to Triassic); Gzheloceratidae Ruzhencev & Shimansky, 1954 (Carboniferous to Permian); Mosquoceratidae Ruzhencev & Shimansky, 1954 (Carboniferous to Permian); Aktubonautilidae Ruzhencev & Shimansky, 1954 (Permian); Rhiphaeoceratidae Ruzhencev & Shimansky, 1954 (Permian); Metacoceratidae Korn, 2025 (Carboniferous to Permian); Foordiceratidae Korn, 2025 (Permian).

Remarks

A detailed discussion of superfamily Pleuronautiloidea has been given by Korn (2025).

Family **Metacoceratidae** Korn, 2025

Diagnosis

Family of the superfamily Pleuronautiloidea with an equidimensional or more commonly weakly depressed, trapezoidal to inverted trapezoidal whorl profile. Venter usually flattened, but ranging from slightly convex to slightly concave. Ventrolateral shoulder often prominent, ranging from broadly rounded to subangular. Flanks weakly convergent, parallel or weakly divergent, usually flattened and ranging from weakly convex to weakly concave. Umbilical margin usually pronounced, usually subangular in the intermediate growth stage. Sculpture with ventrolateral conical nodes, often with dorsolateral nodes and low ribs on the flank. Suture line with shallow lobes and low saddles. Internal lobe very shallow, without annular process (from Korn 2025).

Included genera

Metacoceras Hyatt, 1883 (Carboniferous to Triassic); *Mojsvaroceras* Hyatt, 1883 (Triassic); *Huanghoceras* Yin, 1933 (Permian); ? *Shansinautilus* Yabe & Mabuti, 1935 (Permian); *Cooperoceras* Miller, 1945 (Permian); *Epimetacoceras* Librovtch, 1946 (Carboniferous) (nomen nudum); *Pseudofoordiceras* Ruzhencev & Shimansky, 1954 (Permian); *Pseudotemnocheilus* Ruzhencev & Shimansky, 1954 (Permian); *Tanchiashanites* Zhao, 1954 (Permian); *Mahoningoceras* Murphy,

1974 (Carboniferous); *Lichuanoceras* Xu, 1977 (Permian); *Sinotitanoceras* Pan, 1983 (Permian); *Anthodiscoceras* Qin, 1986 (Permian); *Serometacoceras* gen. nov. (Permian).

Remarks

A detailed account of the research history of *Metacoceras* and genera with similar morphology has been given by Korn (2025). Therefore, only the differences between the new genus *Serometacoceras* gen. nov. and *Metacoceras* will be discussed here.

Genus *Serometacoceras* gen. nov.

urn:lsid:zoobank.org:act:28DA9B4A-3B7E-421E-A054-779F73B20EA9

New genus C – Korn 2025: 50.

Type species

Pleuromutilus Verae von Arthaber, 1900.

Diagnosis

Genus of the family Metacoceratidae with a subinvolute or subevolute conch; whorl profile equidimensional or more or less strongly depressed, usually trapezoidal with weakly divergent flanks. Venter usually weakly convex or flattened; ventrolateral shoulder narrowly or broadly rounded. Umbilical margin pronounced and subangular in the intermediate growth stage, rounded in the adult stage. Sculpture with conical nodes on the ventrolateral shoulder or on the umbilical margin or both, sometimes connected by low ribs on the flank. Suture line with shallow external lobe or very low external saddle and broadly rounded lateral lobe; without annular process. Siphuncle small with subcentral position ventrad of septum centre.

Etymology

From the Latin ‘*serus*’ (adj., net.) = ‘late’; because of the high stratigraphic position and the similarity to *Metacoceras*.

Included species

Transcaucasia and NW Iran (Abich 1878; von Arthaber 1900; Shimansky 1965b; Kotlyar *et al.* 1989; this paper): *Nautilus dorso armatus* Abich, 1878, Wuchiapingian, Azerbaijan; *Nautilus tubercularis* Abich, 1878, Wuchiapingian, Azerbaijan; *Nautilus incertus* Abich, 1878, Wuchiapingian, Azerbaijan; *Nautilus Verae* von Arthaber, 1900, Wuchiapingian, Azerbaijan; *Metacoceras dorashamense* Shimansky, 1965, Wuchiapingian, Azerbaijan; *Pleuromutilus dzhulfensis* Shimansky, 1965, Wuchiapingian, Azerbaijan [synonym of *Serometacoceras verae* gen. et comb. nov.]; *Pleuromutilus costalis* Shimansky, 1965, Wuchiapingian, Armenia; *Pleuromutilus dzhagadzurensis* Zakharov in Kotlyar *et al.*, 1989, Capitanian, Azerbaijan; *Serometacoceras cingulum* gen. et sp. nov., Wuchiapingian, NW Iran; *Serometacoceras inflatum* gen. et sp. nov., Wuchiapingian, NW Iran; *Serometacoceras parvituberculatum* gen. et sp. nov., Wuchiapingian, NW Iran; *Serometacoceras arasense* gen. et sp. nov., Changhsingian, NW Iran.

Central Iran (Korn & Hairapetian in press): new species I to be described by Korn & Hairapetian (in press), Wuchiapingian.

Pakistan (Waagen 1879; Reed 1931, 1944): *Nautilus latissimus* Waagen, 1879, Wuchiapingian, Salt Range; *Gyroceras Medlicottianum* Waagen, 1879, Wuchiapingian, Salt Range; *Metacoceras warchense* Reed, 1931, Wuchiapingian, Salt Range; *Metacoceras chittidilense* Reed, 1944, Wuchiapingian, Salt Range; *Parametacoceras venustum* Reed, 1944, Wuchiapingian, Salt Range.

South China (Xu 1977; Zheng 1984; Ma 1997): *Metacoceras humanense* Xu, 1977, Changhsingian, Hunan; *Pleuronautilus changxingensis* Zhao, Liang & Zheng, 1978, Changhsingian, Zhejiang; *Pleuronautilus zhongyingensis* Zheng, 1984, Changhsingian, Guizhou; *Pleuronautilus magnus* Zheng, 1984, Changhsingian, Guizhou; *Pleuronautilus anfuensis* Ma, 1997, Wuchiapingian, Jiangxi; *Pleuronautilus curvatus* Ma, 1997, Wuchiapingian, Jiangxi; *Pleuronautilus robustus* Ma, 1997, Wuchiapingian, Jiangxi.

Remarks

The Transcaucasian material appears to represent a morphocline ranging from forms with a relatively simple sculpture consisting only of ventrolateral nodes to forms with ribs and a few rows of nodes on the flank. All of these forms have previously been assigned to the genera *Metacoceras* and *Pleuronautilus* Mojsisovics, 1882 (Kummel 1953; Shimansky 1965b; Teichert & Kummel 1973). However, Shimansky (1965b: 158) already noted some uncertainties regarding the exact delimitation of the two genera on the basis of the specimens from Dzhulfa.

A division of the morphocline represented in the material from Julfa into the two genera *Metacoceras* and *Pleuronautilus* would have consequences for the phylogenetic reconstruction of the suborder Tainoceratina. Species previously assigned to *Pleuronautilus* are already known from Early Permian strata, such as the Leonard Formation of Texas. These were placed in the genus *Foordiceras* Hyatt, 1893 by Miller & Youngquist (1949) and in *Pseudofoordiceras* by Ruzhencev & Shimansky (1954). Kummel (1953: 12) discussed at length the phylogenetic relationships within the family Tainoceratidae (as he understood it) and concluded that these species belong to *Pleuronautilus*, a view that was supported by Shimansky (1967). However, this would mean that the origin of the genus *Pleuronautilus* was in the Early Permian or even earlier. Assigning parts of the Transcaucasian morphocline to *Pleuronautilus* would mean that this genus is polyphyletic or that very similar morphologies occur in the genera *Metacoceras* and *Pleuronautilus*.

Dzik (1984: 161) already assumed that the genus *Pleuronautilus*, as previously used by many authors, is a polyphyletic taxon containing several evolutionary lineages. In contrast to previous authors (Kummel 1953; Ruzhencev & Shimansky 1954), who proposed a relatively simple evolutionary scenario starting with the main genus *Metacoceras*, from which most of the other of the tainoceratid genera branched off, Dzik (1984, p. 162, fig. 62) proposed a much more complex picture with a number of independent evolutionary lineages. In this phylogenetic reconstruction, *Metacoceras* does not play a central role and is not considered to be ancestral to genera such as *Tainoceras* Hyatt, 1883 and *Pleuronautilus*. Also, the Late Permian species known from Transcaucasia, which Shimansky (1965b) and Teichert & Kummel (1973) referred to as *Metacoceras* and *Pleuronautilus*, were thought to have evolved independently of *Metacoceras*.

In the following, we place the morphocline with “*Nautilus dorso armatus*” and “*Pleuronautilus verae*” completely in the new genus *Serometacoceras* gen. nov. Some representatives of these Late Permian forms that have previously been placed in *Pleuronautilus* actually have a sculpture very reminiscent of *Pleuronautilus*, but they lack an annular process. Such forms are described by Korn & Hairapetian (in press) as belonging to the new genus C to be described by Korn & Hairapetian (in press).

Serometacoceras gen. nov. differs from *Metacoceras* in the shape of the whorl profile, which in *Serometacoceras* is depressed and usually trapezoidal with weakly divergent flanks, while *Metacoceras* normally has converging flanks. A further difference lies in the formation of the sculpture, which is composed of coarser ribs in *Serometacoceras*.

Serometacoceras dorsoarmatum (Abich, 1878) gen. et comb. nov.
Figs 3C, 17; Table 9

Nautilus dorso armatus Abich, 1878: 20, pl. 4 fig. 1.

Pleuronautilus dorso-armatus – von Arthaber 1900: 215.

Pleuronautilus (Pleuronautilus) dorso-armatus – Kummel 1953: 36.

Metacoceras dorsoarmatum – Shimansky 1965a: 41, pl. 14 fig. 5. — Teichert & Kummel 1973: 417, pl. 3 figs. 5–6.

Diagnosis

Species of *Serometacoceras* gen. nov. with thickly discoidal, subevolute conch ($ww/dm=0.45-0.50$; $uw/dm=0.40-0.45$), weakly depressed whorl profile ($ww/wh=1.15-1.40$) and very high coiling rate ($WER=2.30-2.50$) at a conch diameter of 50 mm. Whorl profile weakly trapezoidal with gently divergent flanks; venter and flanks flattened. Sculpture with 10–12 low ventrolateral nodes per volution; the nodes show a short extension toward the midflank. Suture line with a broad and shallow external lobe and a slightly deeper, broadly rounded lateral lobe.

Material examined

IRAN – **East Azerbaijan** • 1 specimen; Ali Bashi 4; *Araxoceras* Beds of the Julfa Formation (early Wuchiapingian); 2018; Ghaderi leg.; illustrated in Fig. 17A–C; MB.C.32026. – **West Azerbaijan** • 1 specimen; Aras Valley; *Araxoceras* Beds of the Julfa Formation (early Wuchiapingian); 2018; Ghaderi leg.; illustrated in Fig. 17D–F; MB.C.32027 • 1 specimen; same data as for preceding; 2012; Korn *et al.* leg.; illustrated in Fig. 17G; MB.C.32028.

Description

Specimen MB.C.32026 is the largest specimen available; it is a somewhat corroded fragment of an internal mould with a whorl height of 38 mm, corresponding to a conch diameter of about 115 mm (Fig. 17A). Only one third of the whorl is preserved, showing remains of the last three phragmocone chambers and a part of the body chamber. The whorl profile is trapezoidal and slightly depressed ($ww/wh=1.19$) with a broadly rounded venter and a prominent, narrowly rounded ventrolateral shoulder. The flattened flanks are weakly divergent and the umbilical margin is broadly rounded (Fig. 17B). The sculpture consists of very shallow ribs beginning on the inner flank and becoming coarser towards the outer flank where they terminate in transversely elongated, low and blunt ventrolateral nodes. They become much weaker in the last preserved part of the body chamber. It appears that these nodes do not coincide between the two sides of the conch, but rather alternate in position. The suture line of the specimen shows a very broad and flat external lobe, a broadly rounded ventrolateral saddle and a flat, broadly rounded lateral lobe (Fig. 17C).

Specimen MB.C.32027 (Fig. 17D) is an internal mould fragment of a specimen with a conch diameter of about 48 mm, consisting of a quarter of a whorl with the last phragmocone chambers and part of the body chamber. It has a subquadrate, weakly depressed whorl profile ($ww/wh=1.17$) with a flatly rounded venter, a narrowly rounded ventrolateral shoulder, slightly concave and weakly divergent flanks and a raised and thus rather pronounced, but rounded umbilical margin (Fig. 17E). The ventrolateral shoulder bears short radially elongated nodes that extend only a short distance towards the flank, were they are visible only as very low ridges. The umbilical margin bears barely visible, very small tubercles. The suture line has a very shallow external lobe and a broadly rounded lateral lobe (Fig. 17F). The septa are separated by an average of about 13 degrees.

Specimen MB.C.32028 is externally corroded and was sectioned for the study of the inner whorls; it is slightly deformed and was digitally re-deformed for the illustration (Fig. 17G). The cross section shows some ontogenetic changes in the shape of the whorls, starting with a circular profile in the early ontogenetic stage, followed by an inverted trapezoidal shape at a conch diameter of 11.5 mm. Half a volution later, at 19 mm diameter, the whorl profile is rounded-hexagonal with a pronounced, slightly raised umbilical margin and parallel flanks. In the course of half a volution from a conch diameter of 30 to 45 mm, the flanks become clearly divergent and slightly concave. At 39 mm diameter, the section shows a pronounced ventrolateral node extending about 3 mm beyond the ventrolateral shoulder. Finally,

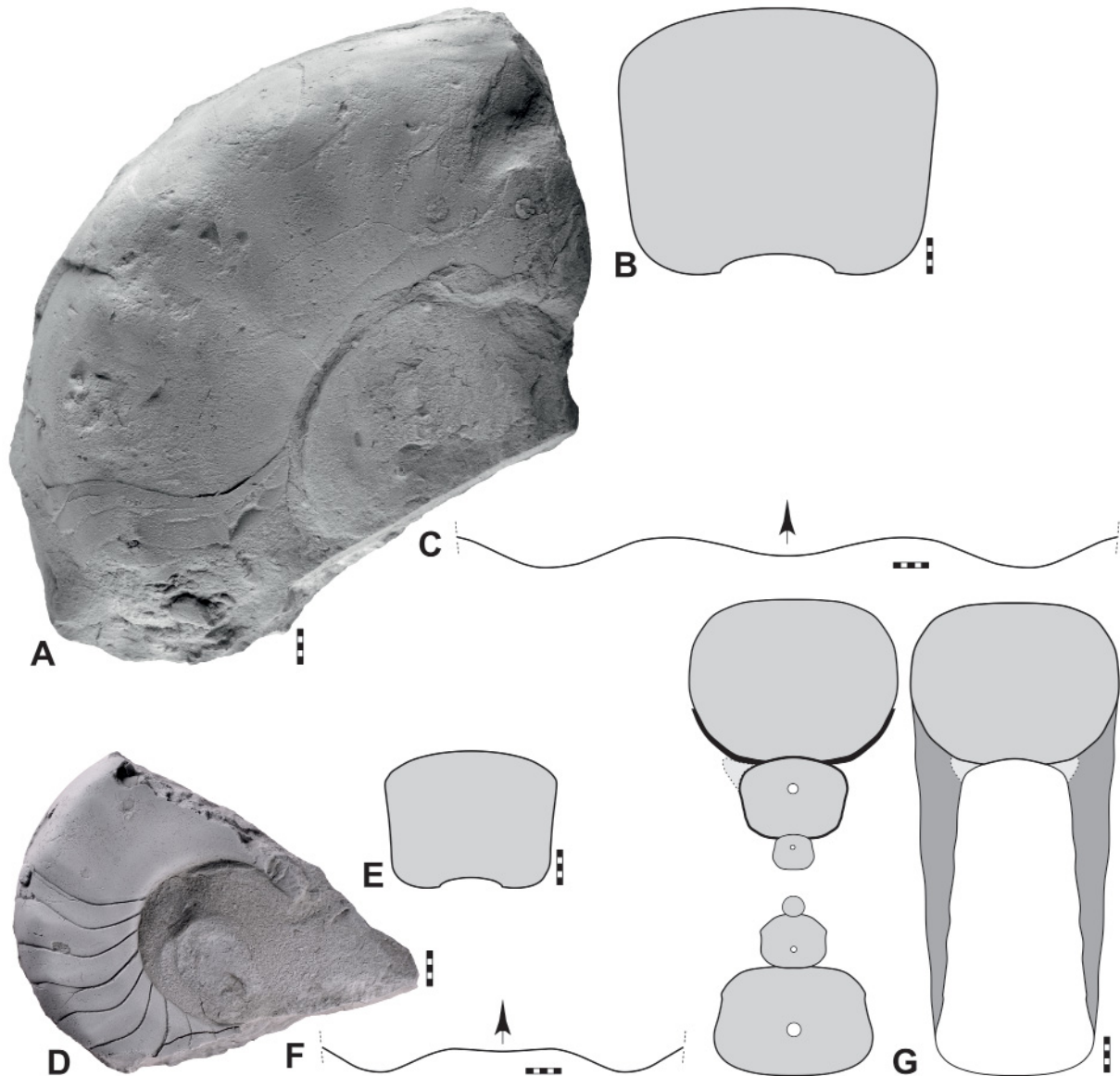

Fig. 17. *Serometacoceras dorsoarmatum* (Abich, 1878) gen. et comb. nov. from the *Araxoceras* Beds of the Julfa Formation. **A.** Specimen MB.C.32026 (Ghaderi 2018 Coll.) from Ali Bashi 4, lateral view. **B.** The same specimen, whorl profile. **C.** The same specimen, suture line at $ww=45.0$ mm, $wh=38.5$ mm. **D.** Specimen MB.C.32027 (Ghaderi 2018 Coll.) from Aras Valley, lateral view. **E.** The same specimen, whorl profile. **F.** The same specimen, suture line at $ww=23.5$ mm, $wh=18.5$ mm. **G.** Specimen MB.C.32028 (Korn *et al.* 2012 Coll.) from Aras Valley, cross section and reconstruction of apertural view. Scale bar units = 1 mm.

Table 9. Conch dimensions (in mm) and ratios of *Serometacoceras dorsoarmatum* (Abich, 1878) gen. et comb. nov.; reconstructed dimensions and ratios in italics.

| Nr. | dm | ww | wh | uw | ah | ww/dm | ww/wh | uw/dm | WER | IZR |
|------------|--------------|------|------|-------------|-------------|-------------|-------|-------------|-------------|-------------|
| MB.C.32026 | <i>115.0</i> | 45.4 | 39.0 | <i>47.0</i> | <i>37.0</i> | <i>0.39</i> | 1.16 | <i>0.41</i> | <i>2.17</i> | <i>0.05</i> |
| MB.C.32027 | <i>48.2</i> | 22.8 | 19.5 | <i>19.4</i> | <i>18.0</i> | <i>0.47</i> | 1.17 | <i>0.40</i> | <i>2.55</i> | <i>0.08</i> |
| MB.C.32028 | 67.9 | 29.8 | 23.6 | 28.8 | 22.7 | 0.44 | 1.26 | 0.42 | 2.26 | 0.03 |
| MB.C.32028 | 45.2 | 22.6 | 15.6 | 18.4 | 15.3 | 0.50 | 1.45 | 0.41 | 2.29 | 0.01 |
| MB.C.32028 | 29.8 | 15.3 | 11.2 | 11.0 | 10.8 | 0.51 | 1.37 | 0.37 | 2.45 | 0.04 |
| MB.C.32028 | 19.1 | 9.4 | 7.7 | 6.4 | 7.4 | 0.49 | 1.23 | 0.34 | 2.66 | 0.04 |
| MB.C.32028 | 11.7 | 5.9 | 5.0 | 3.8 | 5.0 | 0.51 | 1.18 | 0.33 | 3.06 | 0.00 |

the whorl profile of the last volution shows a broadly rounded umbilical margin and flanks that merge continuously into the umbilical wall.

Only minor ontogenetic changes in the cardinal conch parameters can be detected, but it must be taken into account that the ww/dm and ww/wh ratios can be influenced by the position of the cross section relative to the ribs. Whether the section hits a node or interspace is critical to the shape of the whorl profile. However, it can be seen clearly that the uw/dm ratio slowly increases from a value of 0.33 at a conch diameter of 11.5 mm to 0.42 at 68 mm diameter.

Remarks

Abich (1878: pl. 4 fig. 1) illustrated a specimen with a diameter of 53 mm under the name “*Nautilus dorso armatus*, nov. form.”; this fragment allows a fairly accurate description of the morphology of the conch and the sculpture (Fig. 3C). The conch is subevolute (uw/dm ~0.40) with a weakly depressed whorl profile (ww/wh ~1.25). The venter appears to be flattened and the flanks are bordered by a rounded ventrolateral shoulder and a rounded but distinct umbilical margin. The sculpture consists of five laterally directed nodes on half a whorl, which are about half as wide as their interspaces. They are somewhat elongated towards the umbilicus and extend almost to the middle of the flank. The penultimate whorl bears about eight shallow radial riblets on the flank on half a volution. The suture line extends with shallow and rounded lobes across venter, flanks and umbilical wall.

Shimansky (1965b: pl. 14 fig. 5) showed a more complete specimen with a conch diameter of 72 mm; this agrees well with Abich’s original specimen. The close resemblance of these two specimens to the newly collected material from Iran allows a fairly good identification of the new specimens.

Serometacoceras dorsoarmatum gen. et comb. nov. is very similar to *S. dorashamense* gen. et comb. nov., but differs in having considerably shorter ribs, confined to the outer flank. In contrast to *S. dorashamense*, *S. dorsoarmatum* has no umbilical nodes. Another, albeit small, difference lies in the width of the umbilicus. In *S. dorsoarmatum*, the uw/dm ratio is greater than 0.40 and in *S. dorashamense* only around 0.37.

Serometacoceras dorashamense (Shimansky, 1965) gen. et comb. nov.

Fig. 18; Table 10

Metacoceras dorashamense Shimansky, 1965b: 157, pl. 14 fig. 3.

Pleuromutilus sp. indet. 1 – Teichert & Kummel 1973: 418, pl. 1 figs 3–4.

Pleuromutilus sp. – Gliwa *et al.* 2020: text-fig. 17b.

non *Metacoceras dorashamense* – Teichert & Kummel 1973: 416, pl. 4 figs 5–6.

Diagnosis

Species of *Serometacoceras* gen. nov. with thickly discoidal, subevolute conch ($ww/dm=0.45-0.50$; $uw/dm=0.35-0.40$), weakly depressed whorl profile ($ww/wh=1.20-1.30$) and very high coiling rate ($WER=2.30-2.50$) at a conch diameter of 50 mm. Whorl profile nearly rectangular, usually with gently divergent flanks; venter and flanks flattened. Sculpture with 10–12 low ventrolateral nodes per volution; the nodes are connected by slightly curved ribs with weak nodes on the umbilical margin. Suture line with a broad and shallow external lobe and a usually slightly deeper, broadly rounded lateral lobe.

Type material**Holotype**

AZERBAIJAN • Dorasham; *Araxoceras* Beds (early Wuchiapingian); illustrated by Shimansky (1965b: pl. 14 fig. 3); PIN 1572/246.

Material examined

IRAN – **West Azerbaijan** • 1 specimen; Aras Valley; *Araxoceras* Beds of the Julfa Formation (early Wuchiapingian); 2013; Korn *et al.* leg.; illustrated in Fig. 18A–C; MB.C.29347 • 1 specimen; same data as for preceding; 2018; Korn *et al.* leg.; illustrated in Fig. 18D–F; MB.C.32029 • 1 specimen; same data as for preceding; 2018; Ghaderi leg.; illustrated in Fig. 18G–I; MB.C.32030 • 1 specimen; same data as for preceding; 2018; Ghaderi leg.; illustrated in Fig. 18J–L; MB.C.32031 • 5 specimens; same data as for preceding; 2018; Ghaderi leg.; MB.C.32032 to MB.C.32036 • 1 specimen; same data as for preceding; 2011; Korn *et al.* leg.; MB.C.32037 • 2 specimens; same data as for preceding; Korn *et al.* 2013, 2018 Coll.; MB.C.32038, MB.C.32039. – **East Azerbaijan** • 2 specimens; Ali Bashi 4; *Araxoceras* Beds of the Julfa Formation (early Wuchiapingian); 2018; Ghaderi leg.; MB.C.32040, MB.C.32041 • 1 specimen; Ali Bashi main valley; *Araxoceras* Beds of the Julfa Formation (early Wuchiapingian); 2018; Ghaderi leg.; MB.C.32042 • 1 specimen; Zal; *Araxoceras* Beds of the Julfa Formation (early Wuchiapingian); 2018; Ghaderi leg.; MB.C.32043.

Description

Specimen MB.C.29347 is a 120-degree long segment consisting of part of the body chamber and two chambers of the phragmocone. The total diameter can be estimated at approximately 60 mm (Fig. 18B). The specimen has a subquadrate whorl profile with a flattened venter, a rounded ventrolateral shoulder, slightly divergent and weakly concave flanks and a rounded umbilical margin (Fig. 18A).

The sculpture consists of coarse ribs that deviate slightly from the radial direction towards the aperture. They emerge on the inner flank near the umbilical margin with a slightly tubercular thickening, become more prominent in the middle of the flank and, after tapering further, end close to the ventrolateral shoulder in a blunt and elongated tubercle. Ribs and nodes are asymmetrically arranged and not arranged in exact correspondence on both sides of the conch.

Specimen MB.C.32029 is a phragmocone segment of 120 degrees length (Fig. 18E). Its maximum whorl height is 20 mm, which corresponds to a conch diameter of about 50 mm. The whorl profile is weakly depressed and subquadrate ($ww/wh=1.30$) and almost widest at the rounded umbilical margin, from where the flanks very slowly diverge towards the rounded ventrolateral shoulder (Fig. 18D). The venter is flattened and possesses a very shallow concave depression at the beginning of the whorl segment. The sculpture shows five prominent ribs on the segment. These ribs originate at the umbilical margin and extend radially across the flanks; in the outer flank area they strengthen significantly to form large and rounded nodes. The suture line has a rather small and shallow external lobe and a large rounded lateral lobe with asymmetric shape (the ventral side is much longer than the dorsal) and a very shallow, small lobe on the umbilical wall (Fig. 18F).

Table 10. Conch dimensions (in mm) and ratios of *Serometacoceras dorashamense* Shimansky, 1965 gen. et comb. nov.; reconstructed dimensions and ratios in italics.

| Nr. | dm | ww | wh | uw | ah | ww/dm | ww/wh | uw/dm | WER | IZR |
|------------|------|------|------|-------------|------|-------------|-------|-------------|-------------|------|
| MB.C.29347 | 60.0 | 24.2 | 21.5 | <i>19.0</i> | 20.5 | <i>0.40</i> | 1.13 | <i>0.32</i> | <i>2.31</i> | 0.05 |
| MB.C.32031 | 57.1 | 26.4 | 22.2 | <i>21.1</i> | 20.5 | <i>0.46</i> | 1.19 | <i>0.37</i> | <i>2.44</i> | 0.08 |
| MB.C.32030 | 54.3 | 27.4 | 21.2 | <i>19.8</i> | 19.2 | <i>0.50</i> | 1.29 | <i>0.36</i> | <i>2.39</i> | 0.09 |
| MB.C.32029 | 48.7 | 23.6 | 18.2 | <i>18.0</i> | 17.0 | <i>0.48</i> | 1.30 | <i>0.37</i> | <i>2.36</i> | 0.07 |

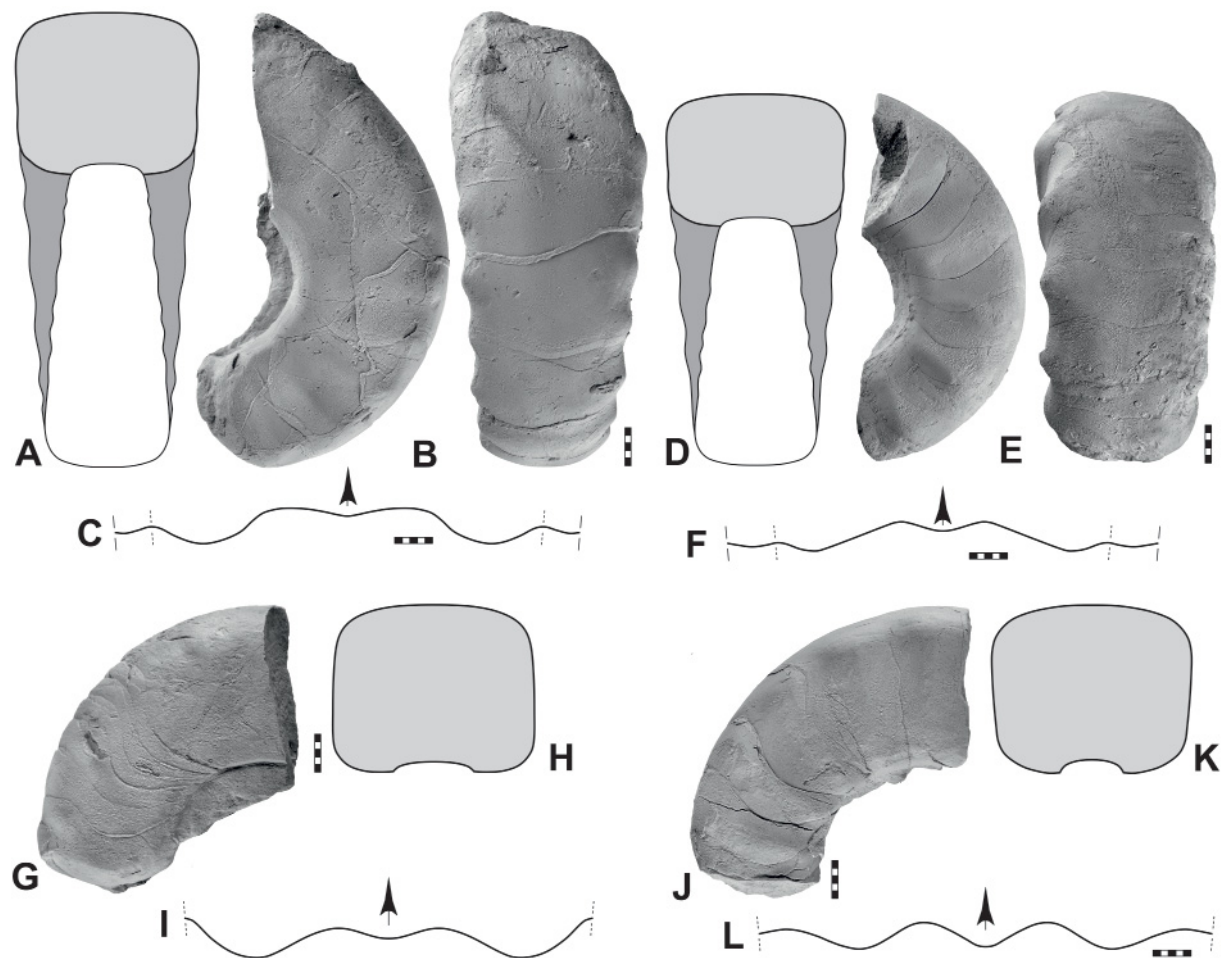

Fig. 18. *Serometacoceras dorashamense* (Shimansky, 1965) gen. et comb. nov. from the *Araxoceras* Beds of the Julfa Formation. **A.** Specimen MB.C.29347 (Korn *et al.* 2013 Coll.) from Aras Valley, reconstruction of apertural view. **B.** The same specimen, lateral and ventral views. **C.** The same specimen, suture line at $ww=19.8$ mm, $wh=20.4$ mm. **D.** Specimen MB.C.32029 (Korn *et al.* 2018 Coll.) from Aras Valley, whorl profile. **E.** The same specimen; lateral and ventral views. **F.** The same specimen, suture line at $ww=20.8$ mm, $wh=15.8$ mm. **G.** Specimen MB.C.32030 (Ghaderi 2018 Coll.) from Aras Valley, ventral and lateral views. **H.** The same specimen, whorl profile. **I.** The same specimen, suture line at $ww=21.5$ mm, $wh=19.5$ mm. **J.** Specimen MB.C.32031 (Ghaderi 2018 Coll.) from Aras Valley, lateral view. **K.** The same specimen, whorl profile. **L.** The same specimen; suture line at $ww=24.2$ mm, $wh=18.9$ mm. Scale bar units = 1 mm.

The fragmentary specimen MB.C.32030 (Fig. 18G; 21 mm whorl height) has a similar shape as specimen MB.C.32029, but is less depressed ($ww/wh=1.19$). The ribs are not as coarse as in the other specimens and the suture line possesses a deeper external lobe (Fig. 18I). The septa are densely arranged at intervals averaging about 10 degrees only.

Specimen MB.C.32031 (Fig. 18J) is a fragment with 22 mm whorl height and possesses a subquadrate whorl profile ($ww/wh=1.19$) with weakly divergent flanks (Fig. 18K). Its sculpture consists of coarse and sharp ribs and the suture line shows a comparatively narrow and deep external lobe (Fig. 18L). The septa are spaced at intervals averaging about 15 degrees.

Remarks

Serometacoceras dorashamense gen. et comb. nov. was established by Shimansky (1965b) mainly on the basis of a rather small holotype with a conch diameter of only 35 mm. The type specimen still shows some early ontogenetic features, such as the distinctly angular umbilical margin and the rather coarse ribs. Although the new material from Iran only consists of fragments, their juvenile morphology can also be seen in the inner whorls of several of the larger specimens. Therefore, an assignment of this material to *S. dorashamense* is fairly certain. The larger specimens from Iran show weakening of the ribs and nodes.

Serometacoceras dorashamense gen. et comb. nov. differs from *S. dorsoarmatum* gen. et comb. nov. in possessing rather coarse ribs on the flanks and small tubercles around the umbilicus. The umbilicus is somewhat narrower in *S. dorashamense* ($uw/dm=0.35-0.40$ when compared to $0.40-0.45$ in *S. dorsoarmatum*).

Another species with similar morphology is *S. verae* gen. et comb. nov. but this differs from *S. dorashamense* gen. et comb. nov. in the more clearly developed umbilical nodes and the occasional presence of an additional row of nodes in the midflank region. A further distinguishing feature is the shape of the venter; in *S. dorashamense* it is flattened and in *S. verae* broadly rounded.

Serometacoceras verae (von Arthaber, 1900) gen. et comb. nov.

Figs 19–20; Table 11

Pleuronautilus Verae von Arthaber, 1900: 216, pl. 18 fig. 4.

Pleuronautilus verae – Shimansky 1965a: 41.

Pleuronautilus (Pleuronautilus) verae – Kummel 1953: 36.

Pleuronautilus dzhulfensis Shimansky, 1965b: 158, pl. 15 figs 5–6.

Nautilus Pichleri – Abich 1878: 21, pl. 4 fig. 2.

Pleuronautilus sp. indet. 2 – Teichert & Kummel 1973: 418, pl. 4 figs 3–4.

Diagnosis

Species of *Serometacoceras* gen. nov. with thickly discoidal, subevolute conch ($ww/dm \sim 0.50$; $uw/dm \sim 0.35$), weakly depressed whorl profile ($ww/wh \sim 1.25$) and very high coiling rate ($WER=2.40-2.50$) at a conch diameter of 50 mm. Whorl profile nearly rectangular, usually with gently convergent flanks; venter broadly convex, flanks flattened. Sculpture with about 15 low ventrolateral nodes per volution; the nodes are connected by slightly curved ribs with weak nodes on the umbilical margin, sometimes with an additional row of nodes on the midflank. Suture line nearly straight on the venter and with a broadly rounded lateral lobe.

Material examined

IRAN – **West Azerbaijan** • 1 specimen; Aras Valley; *Araxoceras* Beds of the Julfa Formation (early Wuchiapingian); 2012; Korn *et al.* leg.; illustrated in Fig. 19A–C; MB.C.32044 • 3 specimens; same data as for preceding; 2018; Ghaderi leg.; MB.C.32046 to MB.C.32048. – **East Azerbaijan** • 1 specimen; Ali Bashi main valley; *Araxoceras* Beds of the Julfa Formation (early Wuchiapingian); 2018; Ghaderi leg.; illustrated in Fig. 19D–E; MB.C.32045 • 1 specimen; Ali Bashi 4; *Araxoceras* Beds of the Julfa Formation (early Wuchiapingian); 2018; Ghaderi leg.; MB.C.32049 • 2 specimens; Ali Bashi; *Araxoceras* Beds of the Julfa Formation (early Wuchiapingian); illustrated in Fig. 20A–B; GLM#GH1002, GLM#GH1004.

Description

Specimen MB.C.32044 is an incomplete conch, consisting of slightly less than half of a volution, with about 50 mm (Fig. 19A). The specimen allows the examination of the cross section of the last two whorls up to 40 mm diameter (Fig. 19B). Of particular interest is that shell remains are preserved on the last whorl; these show that shell thickenings at the umbilical margin, the inner flank and in the ventrolateral area cause a modification in the whorl profile. These thickenings cause tubercles at the umbilical margin and the middle of the flank. The whorl profile of this specimen shows that the conch is widest at the umbilical margin, from where the flanks slowly converge towards the broadly rounded venter, separated by a distinct but rounded ventrolateral shoulder. The siphuncle has a subcentral position with a slight shift towards the venter. It is also slightly displaced towards the right side of the conch.

Specimen MB.C.32045 is the best in the newly collected material, although only half of a whorl is preserved (Fig. 19D). It has a conch diameter of 52 mm and consists of the last part of the phragmocone and part of the body chamber. It is thinly discoidal and subevolute ($ww/dm=0.48$; $uw/dm=0.36$) with a slightly depressed, subquadrate whorl profile ($ww/wh=1.27$). On half of a volution, there are eight short, coarse protracting ribs. They emerge on the inner flank at a short distance from the umbilical margin and become coarser on the flank; they terminate in forming prominent and pointed, radially elongate tubercles at the ventrolateral shoulder. The suture line extends with linear course across the venter and forms a wide and shallow lobe on the flank (Fig. 19E). The septa are densely arranged; they are spaced at intervals averaging about 11 degrees.

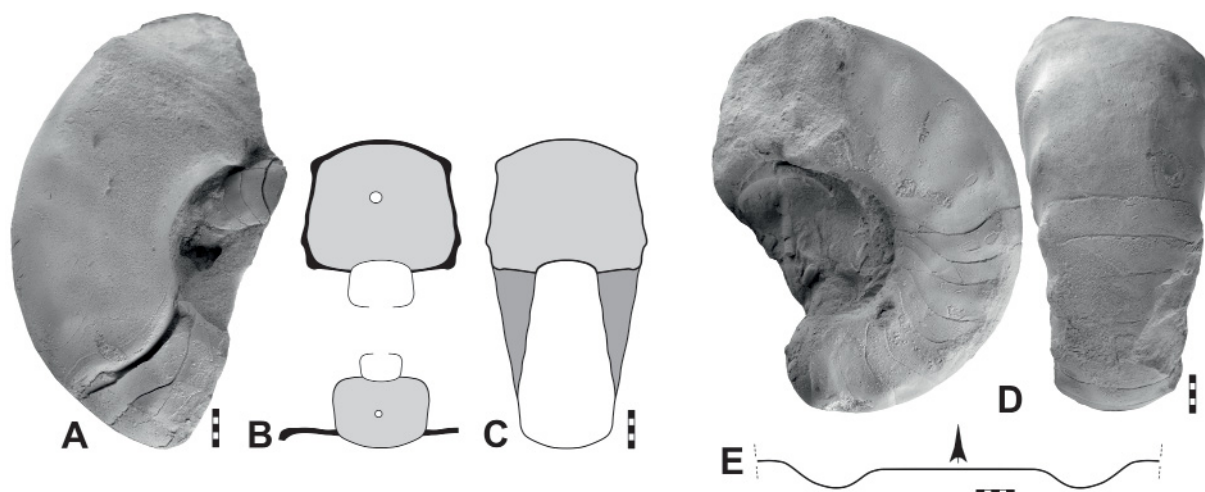

Fig. 19. *Serometacoceras verae* (von Arthaber, 1900) gen. et comb. nov. from the *Araxoceras* Beds of the Julfa Formation. **A.** Specimen MB.C.32044 (Korn *et al.* 2013 Coll.) from Aras Valley, lateral view. **B.** The same specimen, cross section. **C.** The same specimen, reconstruction of apertural view. **D.** Specimen MB.C.32045 (Ghaderi 2018 Coll.) from Ali Bashi Main Valley, lateral and ventral views. **E.** The same specimen, suture line at $ww=20.3$ mm, $wh=18.6$ mm. Scale bar units=1 mm.

Table 11. Conch dimensions (in mm) and ratios of *Serometacoceras verae* (von Arthaber, 1900) gen. et comb. nov.

| Nr. | dm | ww | wh | uw | ah | ww/dm | ww/wh | uw/dm | WER | IZR |
|------------|------|------|------|------|------|-------|-------|-------|------|------|
| MB.C.32045 | 51.3 | 24.9 | 20.2 | 17.9 | 18.2 | 0.49 | 1.23 | 0.35 | 2.40 | 0.10 |
| MB.C.32044 | 40.7 | 21.2 | 17.6 | 13.6 | 15.9 | 0.52 | 1.21 | 0.33 | 2.69 | 0.10 |
| MB.C.32044 | 24.8 | 12.9 | 9.5 | 9.1 | 8.8 | 0.52 | 1.35 | 0.37 | 2.40 | 0.07 |
| MB.C.32044 | 16.0 | 8.7 | 6.2 | – | – | 0.54 | 1.40 | – | – | – |

Remarks

Serometacoceras verae gen. et comb. nov. was almost always placed in the genus *Pleuromutilus* by earlier authors; this was because of the rather coarse ribs and rows of nodes on the flanks, which shows some similarity with the type species *P. trinodosus* Mojsisovics, 1882. However, the great morphological similarity of *S. verae* and *S. dorashamense* gen. et comb. nov. makes such a classification problematic. A separation of the two species into different genera would only make sense if an evolutionary transformation from *S. dorashamense* to *S. verae* was the origin of the genus *Pleuromutilus*. However, the empirical data is not sufficient for such an assumption.

The fragment illustrated by Abich (1878: pl. 4 fig. 2) as “*Nautilus Pichleri* von Hauer” has a whorl height of 18 mm and belongs to an apparently subevolute specimen. It shows straight ribs on the flank; these thicken into nodes in the ventrolateral area. The specimen is most likely to be attributed to *Serometacoceras verae* gen. et comb. nov.

“*Pleuromutilus dzhulfensis*” was described by Shimansky (1965b) with a rather small holotype of a conch diameter of only 42 mm. This specimen agrees well with the figure of the type specimen of *S. verae* gen. et comb. nov. in both conch geometry and sculpture. *S. dzhulfensis* should therefore be considered a synonym.

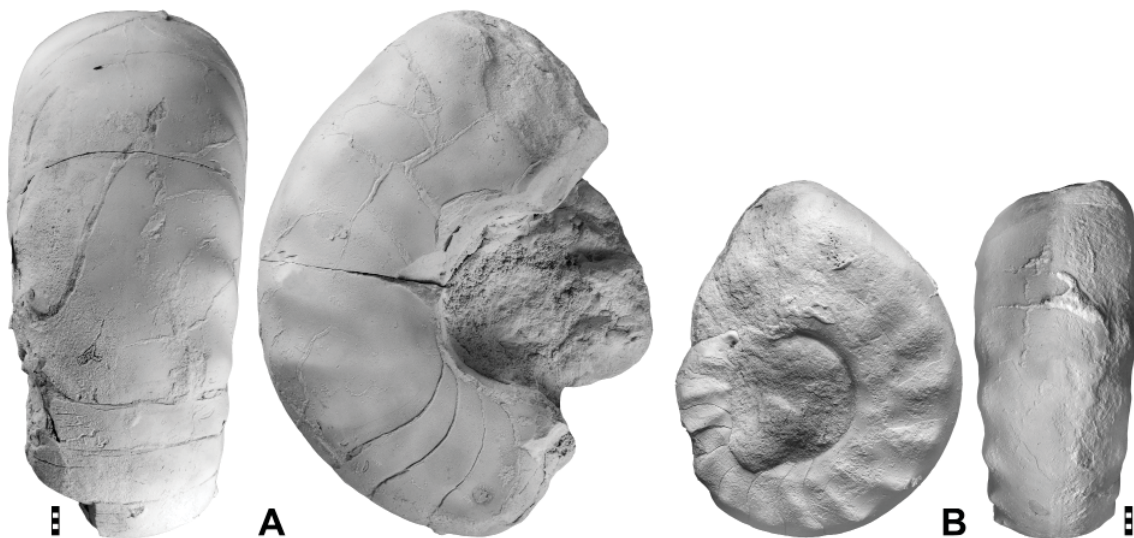

Fig. 20. *Serometacoceras verae* (von Arthaber, 1900) gen. et comb. nov. from the *Araxoceras* Beds of the Julfa Formation of Ali Bashi. **A.** Specimen GLM#GH1004, ventral and lateral views. **B.** Specimen GLM#GH1002, lateral and ventral views. Scale bar units = 1 mm.

Serometacoceras dorashamense gen. et comb. nov. is a similar species but differs from *S. verae* gen. et comb. nov. in possessing weaker umbilical nodes; in addition, *S. verae* sometimes has an additional row of nodes on the middle flank, in contrast to *S. dorashamense*. Another distinguishing feature is the shape of the venter; it is broadly rounded in *S. verae* and flattened in *S. dorashamense*.

***Serometacoceras cingulum* gen. et sp. nov.**

urn:lsid:zoobank.org:act:811CF4A8-04D5-4466-90F8-FCDA8FD9BCB

Fig. 21

Pleurometacoceras spec. indet. ex aff. *Wynnei* – von Arthaber 1900: 214, pl. 18 fig. 3.

Temnocheilus sp. indet. – Teichert & Kummel 1973: 419, pl. 3 figs 7–8.

Diagnosis

Species of *Serometacoceras* gen. nov. with subevolute conch and moderately depressed whorl profile (ww/dm ~ 1.75). Whorl profile broadly trapezoidal with gently divergent flanks; venter flattened, flanks slightly concave. Sculpture with about 15 prominent, blunt ventrolateral nodes per volution; the nodes are connected by blunt ribs across the flanks. Suture line with a broad and shallow external lobe and a usually slightly deeper, broadly rounded lateral lobe.

Etymology

From the Latin ‘*cingulum*’ (noun, n.)=‘a belt’; because of the belt-shaped conch.

Type material

Holotype

IRAN – **West Azerbaijan** • Zal; *Araxoceras* Beds of the Julfa Formation (early Wuchiapingian); 2013; Korn *et al.* leg.; illustrated in Fig. 21; MB.C.32050.

Description

The fragmentary holotype MB.C.32050 is a whorl segment of about 75 degrees (Fig. 21A). It has, at a whorl height of 20 mm, a moderately depressed trapezoidal whorl profile (ww/wh=1.73) (Fig. 21B). On the segment, there are three prominent ventrolateral nodes, which possess an elongation across the flanks and wedge out at the narrowly rounded umbilical margin. The suture line appears to be regularly undulated with shallow, broadly rounded lobes on venter and flanks, respectively; the internal lobe is

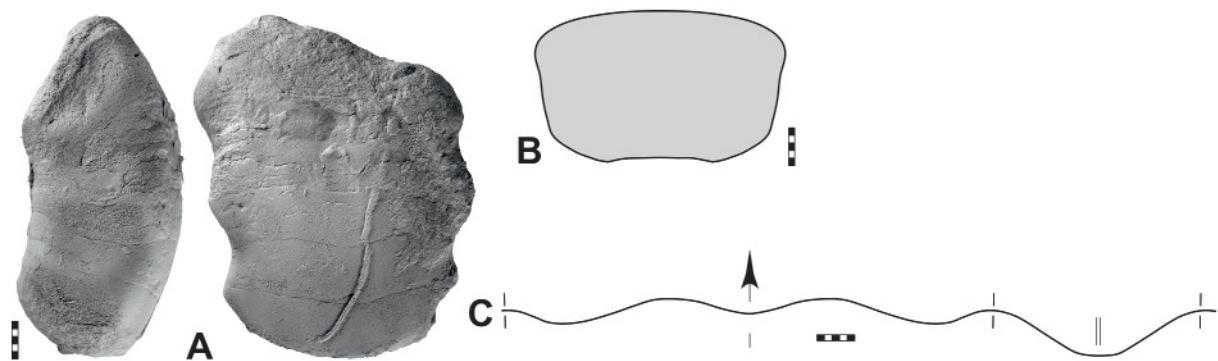

Fig. 21. *Serometacoceras cingulum* gen. et sp. nov., holotype MB.C.32050 (Korn *et al.* 2013 Coll.) from the *Araxoceras* Beds of the Julfa Formation of Zal. **A.** Lateral and ventral views. **B.** Whorl profile. **C.** Suture line at ww=28.4 mm, wh=19.3 mm. Scale bar units=1 mm.

broadly rounded and twice as deep as the external and lateral lobes (Fig. 21C). The septa are densely arranged in the fragment; they are spaced at intervals averaging about 10 degrees only.

Remarks

Although only one newly collected specimen is available, a new species is described because of the very distinctive conch shape. *Serometacoceras cingulum* gen. et sp. nov. has a similar sculpture to that of *S. dorashamense* gen. et comb. nov., but differs in that it has a much broader whorl profile (ww/wh ~1.75 in *S. cingulum*, but only ~1.25 in *S. dorashamense*). The very broad whorl profile is also a distinguishing feature from other species of the genus.

Serometacoceras inflatum gen. et sp. nov.

urn:lsid:zoobank.org:act:3427133D-E4DC-4F28-AEE9-4F943185F2AC

Fig. 22; Table 12

Metacoceras dorashamense – Teichert & Kummel 1973: 416, pl. 4 figs 5–6.

Diagnosis

Species of *Serometacoceras* gen. nov. with thickly discoidal, subinvolute conch (ww/dm ~0.55; uw/dm ~0.28), weakly depressed whorl profile (ww/wh ~1.30) and very high coiling rate (WER ~2.55) at a conch diameter of 40 mm. Whorl profile rounded-pentagonal with broadly rounded venter and flattened, gently divergent flanks and subangular umbilical margin. Sculpture with about 15 short lateral ribs per volution. Suture line with broadly rounded external saddle and shallow, broadly rounded lateral lobe.

Etymology

From the Latin ‘*inflatum*’ (adjective, n.)= ‘inflated’; because of the ventrally inflated whorl profile.

Type material

Holotype

IRAN – West Azerbaijan • Aras Valley; *Araxoceras* Beds of the Julfa Formation (early Wuchiapingian); 2018; Ghaderi leg.; illustrated in Fig. 22; MB.C.32051.

Description

Specimen MB.C.32051 is a fully chambered fragment almost 180 degrees long; the diameter of the conch is 40 mm (Fig. 22A). It is an internal mould partially covered by a tabulate reptant coral. The specimen has been ground to obtain a cross section of the conch and shows two volutions. The conch

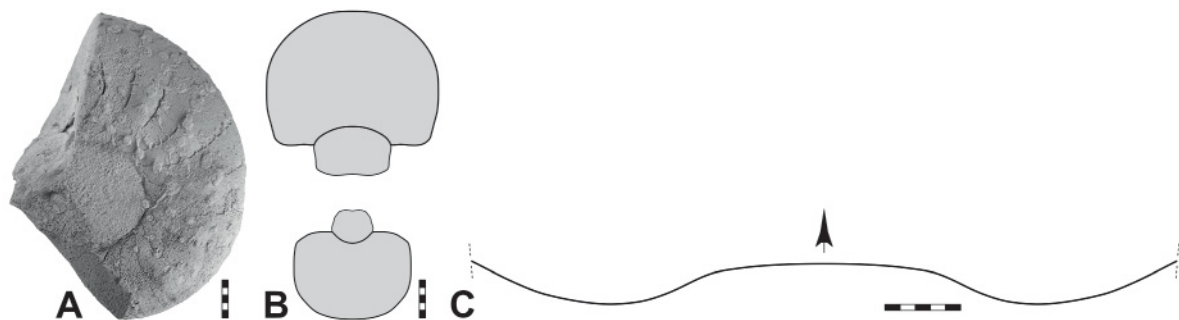

Fig. 22. *Serometacoceras inflatum* gen. et sp. nov., holotype MB.C.32051 (Ghaderi 2018 Coll.) from the *Vedioceras* Beds of the Julfa Formation at Aras Valley. **A.** Lateral view. **B.** Cross section. **C.** Suture line at ww=18.8 mm, wh=14.5 mm. Scale bar units=1 mm.

Table 12. Conch dimensions (in mm) and ratios of *Serometacoceras inflatum* gen. et sp. nov.; reconstructed values in italics.

| Nr. | dm | ww | wh | uw | ah | ww/dm | ww/wh | uw/dm | WER | IZR |
|------------|------|------|------|-------------|------|-------------|-------|-------------|------|------|
| MB.C.32051 | 40.6 | 22.7 | 17.7 | <i>11.4</i> | 15.2 | <i>0.56</i> | 1.28 | <i>0.28</i> | 2.55 | 0.14 |
| MB.C.32051 | 25.4 | 15.5 | 11.5 | <i>7.5</i> | 10.0 | <i>0.61</i> | 1.34 | <i>0.29</i> | 2.73 | 0.13 |
| MB.C.32051 | 15.4 | 10.2 | 6.4 | 4.4 | 6.4 | 0.66 | 1.59 | 0.29 | – | 0.00 |

is thickly discoidal and subinvolute ($ww/dm \sim 0.55$; $uw/dm \sim 0.28$) with a weakly depressed whorl profile ($ww/wh \sim 1.30$) that shows a rather deep concave zone ($IZR \sim 0.15$). The calculated coiling rate is extremely high ($WER \sim 2.55$). At a conch diameter of 40 mm, the whorl profile is characterised by a broadly rounded venter that merges continuously into the flanks, a pronounced umbilical margin and a flat umbilical wall, which is arranged perpendicular to the plane of symmetry. One volution earlier, the whorl profile is depressed rectangular ($ww/wh \sim 1.60$) with a rather well-defined ventrolateral shoulder.

The sculpture consists of short and rather coarse, blunt ribs on the flank; these ribs are weakly strengthened on the outer flank and form radially elongated conical nodes. The suture line shows a broadly rounded saddle on the venter and a broadly rounded lobe on the flank. The last half volution shows eleven chambers of the phragmocone. The septa are rather widely arranged; they are spaced at intervals averaging about 16 degrees.

Remarks

Although only one newly collected specimen is available, a new species is described for the very distinctive conch shape. *Serometacoceras inflatum* gen. et sp. nov. differs from the other species of the genus mainly by the short ribs in the middle of the flank. In contrast to the other species of the genus, these ribs are only very slightly thickened in the ventrolateral area. Another distinguishing feature is the broadly rounded venter. Only *S. verae* gen. et comb. nov. is similar in this respect, but this species is distinguished by a sculpture with rows of conical tubercles. Furthermore, *S. inflatum* is narrower umbilicate ($uw/dm \sim 0.28$) than *S. verae* ($uw/dm \sim 0.33$) at a conch diameter of 40 mm.

Serometacoceras tuberculare (Abich, 1878) gen. et comb. nov.

Fig. 3F

Nautilus tubercularis Abich, 1878: 20, pl. 4 fig. 1.

Pleuronautilus tubercularis – Shimansky 1965b: pl. 15 fig. 1.

Remarks

The specimen illustrated by Abich (1878: pl. 9 fig. 1) as “*Nautilus tubercularis*, nov. form.” has a conch diameter of about 85 mm and is obviously a weathered specimen (Fig. 3F). It suggests a discoidal, subevolute conch with a subquadrate whorl profile ($ww/dm=0.38$; $uw/dm=0.35$; $ww/wh=0.91$). The flanks are apparently flattened and are almost parallel; they are separated from the concave venter by a rounded ventrolateral shoulder. Half a volution bears ten ribs on the flank; these extend following a straight line in prorsiradiate direction. They begin at the umbilical margin and progressively increase to slightly raised nodules on the outer flank.

Shimansky (1965b: pl. 15 fig. 1) figured a specimen with a conch diameter of almost 40 mm. This shows an almost quadrate whorl profile with parallel flanks. The sculpture consists of five coarse ribs per quarter volution. These ribs begin at the umbilical margin and extend over the flank with a low projection. In the ventrolateral area they become stronger and form nodes.

Serometacoceras incertum (Abich, 1878) gen. et comb. nov.
Fig. 3D

Nautilus incertus Abich, 1878: pl. 4 fig. 3.

Pleurometacoceras (Pleurometacoceras) incertus – Kummel 1953: 36.

? *Pleurometacoceras incertus* – Shimansky 1965b: pl. 15 fig. 3.

Remarks

Abich (1878: pl. 4 fig. 3) illustrated a small fragment with about 15 mm whorl width in ventral view (Fig. 3D). He called this specimen “*Nautilus incertus*” in the table explanation, but he described it (Abich 1878: 21) only as the second specimen of “*Nautilus Pichleri*” (Fig. 3E). The specimen possesses a flattened venter and bears ventrolateral nodes. A species definition can probably not be based on this specimen. It is not even clear whether Abich had any taxonomic naming of the specimen in mind at all; von Arthaber (1900: 216) already suspected that the term “*incertus*” should only mean “indeterminable”.

For this reason, but also because of the small size of Abich’s specimen, a clear species description is not possible. It is also not clear whether the much larger specimen shown by Shimansky (1965b: pl. 15 fig. 3) can be classified as “*incertus*”. The species can therefore only be included with reservations.

Serometacoceras parvituberculatum gen. et sp. nov.

urn:lsid:zoobank.org:act:21B9A6C8-C25F-45BA-9C7B-916810D7912A

Fig. 23; Table 13

Diagnosis

Species of *Serometacoceras* gen. nov. with thinly pachyconic, subevolute conch (ww/dm ~0.70; uw/dm ~0.35), moderately depressed whorl profile (ww/wh ~1.75) and very high coiling rate (WER ~2.40) at a conch diameter of 40 mm. Whorl profile rounded rectangular with flattened, gently divergent flanks; venter flatly rounded, flanks flattened, umbilical margin subangular. Sculpture with weak lateral ribs ending in small ventrolateral tubercles.

Etymology

Combination of the Latin ‘*parvum*’ (adjective, n.)= ‘small’ and ‘*tuberculum*’ (noun, n.); because of the small ventrolateral tubercles.

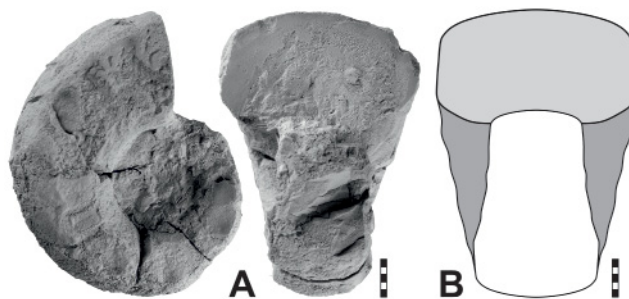

Fig. 23. *Serometacoceras parvituberculatum* sp. nov., holotype MB.C.32052 (Ghaderi 2018 Coll.) from the *Vedioceras* Beds of the Julfa Formation at Zal. **A.** Lateral and apertural views. **B.** Reconstruction of apertural view. Scale bar units= 1 mm.

Table 13. Conch dimensions (in mm) and ratios of the holotype of *Serometacoceras parvituberculatum* gen. et sp. nov.

| Nr. | dm | ww | wh | uw | ah | ww/dm | ww/wh | uw/dm | WER | IZR |
|------------|------|------|------|------|------|-------|-------|-------|------|------|
| MB.C.32052 | 38.2 | 26.7 | 15.4 | 13.0 | 13.6 | 0.70 | 1.73 | 0.34 | 2.41 | 0.12 |

Type material

Holotype

IRAN – **East Azerbaijan** • Zal; *Vedioceras* Beds of the Julfa Formation (late Wuchiapingian); 2018; Ghaderi leg.; illustrated in Fig. 23; MB.C.32052.

Description

Holotype MB.C.32052 is a rather poorly preserved specimen with a conch diameter of 38 mm (Fig. 23A). It is thinly pachyconic ($ww/dm=0.70$) and subevolute ($uw/dm=0.34$) with a nearly rectangular, moderately depressed whorl profile ($ww/wh=1.73$) and a very high coiling rate ($WER=2.40$). The whorls are widest at the umbilical margin, from where the weakly convex umbilical wall approaches the umbilical seam. The flanks converge slowly towards the pronounced, narrowly rounded ventrolateral shoulders; the venter is broadly arched (Fig. 23B). The main element of the sculpture consists of delicate lateral ribs ending in a series of small tubercles on the ventrolateral shoulder. The suture line is visible only on the flanks and the umbilical wall, both of which have very shallow, broadly rounded lobes.

Remarks

Serometacoceras parvituberculatum gen. et sp. nov. differs from the other species of the genus in the very small and more numerous ventrolateral tubercles.

Serometacoceras arasense gen. et sp. nov.

urn:lsid:zoobank.org:act:05175D5D-1AC6-4527-AEF5-57CDC0E9EDC3

Fig. 24; Table 14

Pleuonautilus sp. – Gliwa *et al.* 2020: text-fig. 17d.

Diagnosis

Species of *Serometacoceras* gen. nov. with thinly discoidal, subinvolute conch ($ww/dm \sim 0.45$; $uw/dm \sim 0.28$), nearly quadrate whorl profile ($ww/wh \sim 0.90$) and extremely high coiling rate ($WER \sim 2.70$) at a conch diameter of 80 mm. Whorl profile flattened, parallel flanks; venter broadly rounded, flanks slightly flattened, umbilical margin subangular. Sculpture with about 15 short lateral plications per volution.

Etymology

Named after the type locality at the Aras River (West Azerbaijan, Iran).

Type material

Holotype

IRAN – **West Azerbaijan** • Aras Valley; Zal Member of the Ali Bashi Formation (9.50 m below top) (early Changhsingian); 2011; Korn *et al.* leg.; illustrated in Fig. 24; MB.C.29349.

Description

Holotype MB.C.29349 is rather complete and has a conch diameter of 82 mm (Fig. 24B). It is preserved with adherent shell material but does not show the suture line. The conch is thinly discoidal and

Table 14. Conch dimensions (in mm) and ratios of the holotype of *Serometacoceras arasense* gen. et sp. nov.; estimated values in italics.

| Nr. | dm | ww | wh | uw | ah | ww/dm | ww/wh | uw/dm | WER | IZR |
|------------|------|------|------|------|-------------|-------|-------|-------|-------------|-------------|
| MB.C.29349 | 81.5 | 35.5 | 38.4 | 22.8 | <i>32.0</i> | 0.43 | 0.92 | 0.28 | <i>2.70</i> | <i>0.17</i> |

subinvolute ($ww/dm \sim 0.43$; $uw/dm = 0.28$); the whorl profile is slightly compressed and subquadrate ($ww/wh = 0.92$) with flattened, parallel flanks, a pronounced ventrolateral shoulder and a broadly rounded venter (Fig. 24A). The umbilical margin is subangular in the last half of a volution with an obliquely oriented umbilical wall. In contrast, the penultimate volution (up to about 30 mm dm) has a very pronounced umbilical margin and an almost vertical umbilical wall.

The sculpture of the last volution is dominated by weakly protracted radial plications. They begin at the umbilical margin, where they bear small tubercles, and gain in strength across the flanks. They terminate at the ventrolateral shoulder where they are coarsest and bear another row of tubercles. The umbilical opening allows the study of the sculpture in the preceding whorl, in which the ribs are much coarser than in the last and the umbilical margin is more pronounced and bears a ridge occupied with small tubercles.

Remarks

Serometacoceras arasense gen. et sp. nov. differs from *S. costale* (Shimansky, 1965) gen. et comb. nov. in the shape of the whorl profile; in *S. arasense* the ww/wh ratio is about 0.90 and in *S. costale* only 0.60–0.70 (Shimansky 1965b). In addition, *S. arasense* has significantly coarser radial ribs than *S. costale*.

Serometacoceras arasense gen. et sp. nov. differs from the other species of the genus *Serometacoceras* gen. nov. of Julfa by the prominent umbilical margin in the adult stage.

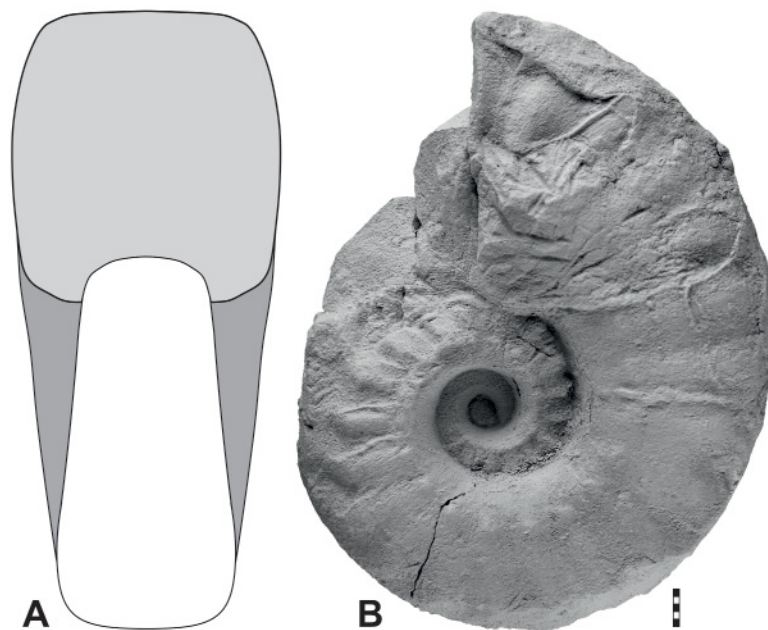

Fig. 24. *Serometacoceras arasense* gen. et sp. nov., holotype MB.C.29349 (Korn *et al.* 2011 Coll.) from the Zal Member of the Ali Bashi Formation (9.50 m below top) at from Aras Valley. **A.** Reconstruction of apertural view. **B.** Lateral view. Scale bar units = 1 mm.

Family **Rhiphaeoceratidae** Ruzhencev & Shimansky, 1954

Diagnosis

Family of the superfamily Pleuronautiloidea with a small, slender first whorl. Whorl profile weakly depressed, elliptical or trapezoidal. Venter broad and weakly convex, flanks convex or slightly flattened and umbilical margin broadly rounded or absent. Sculpture with short ribs on the flank. Suture line with a low external saddle, sometimes with a shallow external lobe, a very shallow lateral and a rather deep funnel-shaped internal lobe; without annular process (after Ruzhencev & Shimansky 1954).

Included genera

Rhiphaeoceras Ruzhencev & Shimansky, 1954 (Permian); *Pararhiphaeoceras* Ruzhencev & Shimansky, 1954 (Permian); *Sholakoceras* Ruzhencev & Shimansky, 1954 (Permian); *Rhiphaeonautilus* Ruzhencev & Shimansky, 1954 (Permian); *Eximioceras* Shchedukhin, 2022 (Permian); *Alibashinautilus* gen. nov. (Permian).

Remarks

The family Rhiphaeoceratidae can be distinguished from other Permian nautiloids by their suture line with its rather deep internal lobe. The only exceptions are the representatives of the family Aktubonautilidae, but these differ in having a much larger juvenile conch.

Genus *Alibashinautilus* gen. nov.

urn:lsid:zoobank.org:act:BD4CEDE2-0145-467A-BD60-AD2C0216959E

New genus D – Korn 2025: 55.

Type species

Alibashinautilus vetus gen. et sp. nov.

Diagnosis

Genus of the family Rhiphaeoceratidae with subevolute or evolute conch; whorl profile circular or slightly compressed or depressed with broadly rounded venter and flanks. Sculpture with low, rounded radial ribs on the flanks or without ribs. Suture line with shallow external lobe and broadly rounded lateral lobe; internal lobe rather deep, without annular process.

Etymology

Combination of Ali Bashi and *Nautilus*; because of the type locality of the type species.

Included species

NW Iran (this paper): *Alibashinautilus vetus* gen. et sp. nov., Wuchiapingian; *Alibashinautilus ambiguus* gen. et sp. nov., Changhsingian.

Remarks

The new genus comprises species with a simple conch morphology. These are widely umbilicate forms with a circular or weakly compressed whorl profile and a low coiling rate. This morphology distinguishes them from the vast majority of Late Carboniferous and Permian nautilids. The simple morphology of these species makes it challenging to determine their genus and family. It is unclear whether they belong to a conservative evolutionary lineage of simple forms or if they are a result of morphological simplification from more complex forms.

The placement of the new genus in the family Rhiphaeoceratidae is based on the shape and sculpture of the shell. *Alibashinautilus* gen. nov., like *Rhiphaeoceras*, has a rather simple oval, rounded whorl

profile. However, the juvenile conch is not preserved in the Julfa material, so it is not known whether the first whorl is small, as in the Rhiphaeoceratidae, or large, as in the Aktubonautilidae. Therefore, the assignment of *Alibashinautilus* can only be made with reservations.

Alibashinautilus vetus gen. et sp. nov.

urn:lsid:zoobank.org:act:4C7D84B1-4455-4069-A54B-3033FEB384A0

Figs 25–27; Table 15

Diagnosis

Species of *Alibashinautilus* gen. nov. with thinly discoidal, evolute conch ($ww/dm \sim 0.35$; $uw/dm \sim 0.50$), equidimensional or weakly depressed whorl profile ($ww/wh \sim 1.10$ – 1.30) and moderately high coiling rate ($WER \sim 1.85$) at a conch diameter of 100–140 mm. Whorl profile nearly circular with continuously rounded venter and flanks; whorl overlap very small. Sculpture with short, coarse ribs on the outer flank. Suture line with wide and very shallow external lobe, very shallow lateral lobe and rather narrow, deep internal lobe.



Fig. 25. *Alibashinautilus vetus* gen. et sp. nov., holotype MB.C.32053 (Ghaderi 2018 Coll.) from the *Araxoceras* Beds of the Julfa Formation at Aras Valley; lateral and ventral views. Scale bar units = 1 mm.

Etymology

From the Latin ‘*vetus*’ (adj., m.)= ‘old’; since the species has a morphology similar to that of much older nautiloids.

Type material

Holotype

IRAN – **West Azerbaijan** • Aras Valley; *Araxoceras* Beds of the Julfa Formation (early Wuchiapingian); 2018; Ghaderi leg.; illustrated in Figs 25, 26A–B; MB.C.32053.

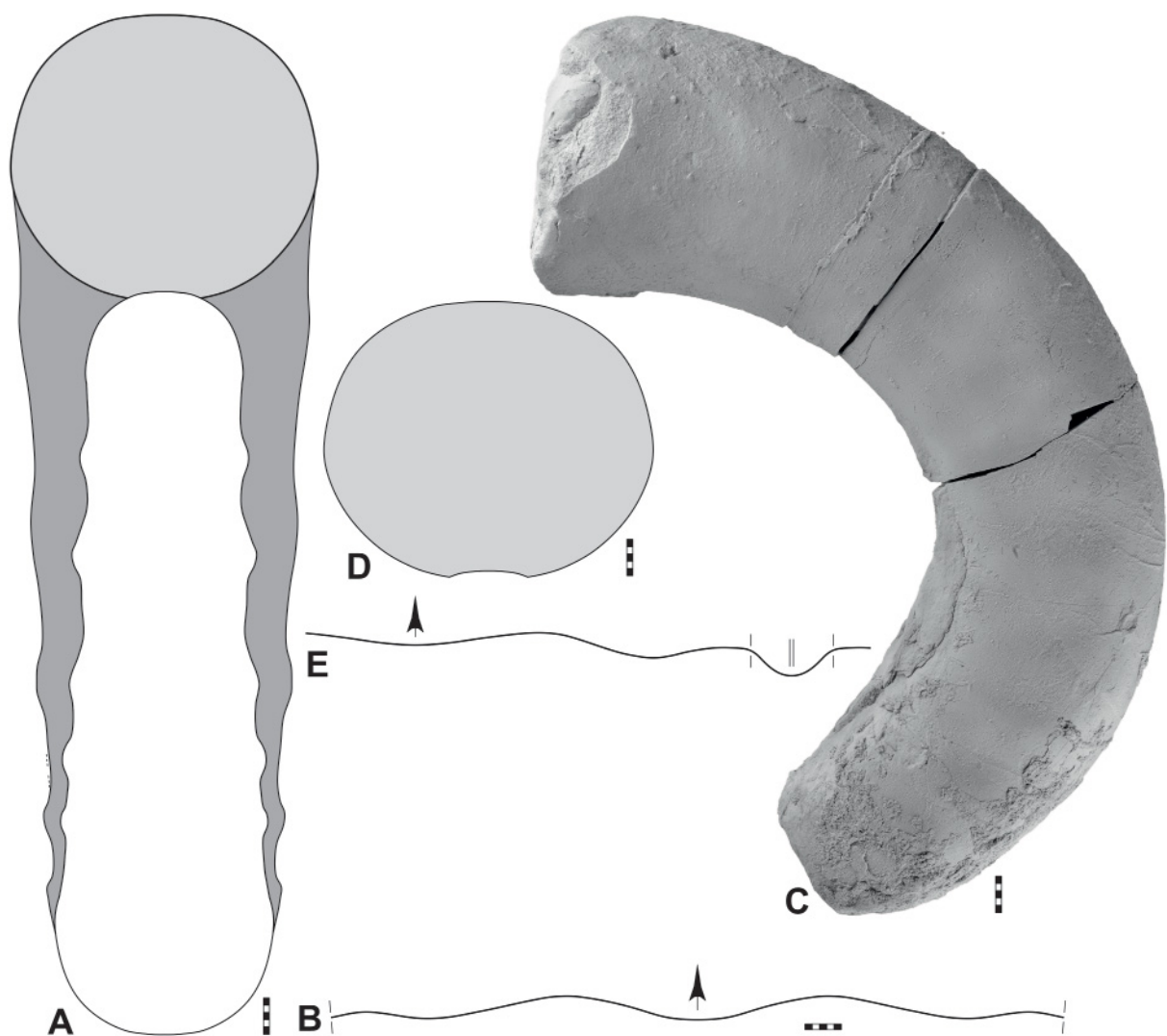

Fig. 26. *Alibashinautilus vetus* gen. et sp. nov. **A.** Holotype MB.C.32053 (Ghaderi 2018 Coll.) from the *Araxoceras* Beds of the Julfa Formation at Aras Valley, reconstruction of apertural view. **B.** The same specimen, suture line at dm=94.0 mm, ww=32.5 mm, wh=26.5 mm. **C.** Paratype MB.C.32054 (Ghaderi 2018 Coll.) from the *Araxoceras* Beds of the Julfa Formation at Ali Bashi, main valley, lateral view. **D.** The same specimen, whorl profile. **E.** The same specimen, suture line at ww=35.4 mm, wh=30.2 mm. Scale bar units= 1 mm.

Paratypes

IRAN – **East Azerbaijan** • 1 specimen; Ali Bashi, main valley; *Araxoceras* Beds of the Julfa Formation (early Wuchiapingian); 2018; Ghaderi leg.; illustrated in Fig. 26C–E; MB.C.32054 • 1 specimen; Ali Bashi; *Araxoceras* Beds of the Julfa Formation (early Wuchiapingian); illustrated in Fig. 27; GLM#GH1006.

Description

Holotype MB.C.32053 is an incomplete internal mould with a diameter of almost 140 mm (Fig. 25). The study of conch shape and sculpture is only possible for about three quarters of the last volution, as the inner whorls are poorly preserved due to recrystallisation. The conch is thinly discoidal and evolute ($ww/dm=0.30$; $uw/dm=0.50$) and the whorl profile is nearly circular and slightly depressed ($ww/wh=1.09$). The overlap zone of the whorls is very small (Fig. 26A) and the coiling rate is moderately high ($WER=1.85$).



Fig. 27. *Alibashinautilus vetus* gen. et sp. nov., paratype GLM#GH1006 from the *Araxoceras* Beds of the Julfa Formation from Julfa, ventral and lateral views. Scale bar units=1 mm.

Table 15. Conch dimensions (in mm) and ratios of *Alibashinautilus vetus* gen. et sp. nov.

| Nr. | dm | ww | wh | uw | ah | ww/dm | ww/wh | uw/dm | WER | IZR |
|------------|-------|------|------|------|------|-------|-------|-------|------|------|
| MB.C.32053 | 139.4 | 42.4 | 38.5 | 69.5 | 37.0 | 0.30 | 1.10 | 0.50 | 1.85 | 0.04 |
| MB.C.32053 | 101.4 | 34.2 | 28.4 | 48.4 | 26.5 | 0.34 | 1.20 | 0.48 | 1.83 | 0.07 |
| MB.C.32054 | 132.0 | 49.2 | 38.5 | 69.0 | 36.5 | 0.37 | 1.28 | 0.52 | 1.91 | 0.05 |

The sculpture consists of prominent ribs, which are coarsest in the ventrolateral region and gradually decrease in strength towards the umbilicus. On the body chamber, these ribs become weaker, and at the greatest diameter of the specimen, only shallow radial folds remain. Half a volution has thirteen ribs. The suture line shows shallow undulation with broadly rounded lobes and saddles and a rather narrow, rounded internal lobe (Fig. 26B).

Paratype MB.C.32054 is a whorl segment of nearly half a volution and comprising of two chambers of the phragmocone and a long portion of the body chamber (Fig. 26C). Its conch diameter can be estimated with about 132 mm. The conch is serpenticonic with a wide umbilicus ($uw/dm \sim 0.52$) and a weakly depressed subcircular whorl profile ($ww/wh = 1.28$). The coiling rate is moderate ($WER \sim 1.91$) and the whorl overlap zone very small (Fig. 26D).

The sculpture is composed of low ribs confined to the flanks. They are coarsest in the ventrolateral area and become continuously weaker across the flanks before they disappear near the umbilicus. The siphuncle has a subcentral position on the dorsal side at about a quarter of the whorl height.

Remarks

Alibashinautilus vetus gen. et sp. nov. can be easily distinguished from *A. ambiguus* gen. et sp. nov. by the coarser ribs on the outer flank. Other differences are the greater width of the umbilicus ($uw/dm \sim 0.50$ in *A. vetus*, but only ~ 0.37 in *A. ambiguus*) and the lower coiling rate ($WER \sim 1.85$ in *A. vetus* in contrast to ~ 2.30 in *A. ambiguus*).

Alibashinautilus ambiguus gen. et sp. nov.

urn:lsid:zoobank.org:act:581650DC-6AA3-4D6E-9DA5-5409F4945D92

Fig. 28; Table 16

Diagnosis

Species of *Alibashinautilus* gen. nov. with thinly discoidal, subevolute conch ($ww/dm \sim 0.35$; $uw/dm \sim 0.35$), weakly circular whorl profile ($ww/wh \sim 1.00$) and very high coiling rate ($WER \sim 2.30$) at a conch diameter of 120 mm. Whorl profile nearly circular with continuously rounded venter and flanks; whorl overlap very small. Ornament without ribs. Suture line with wide and very shallow external lobe and very shallow lateral lobe.

Etymology

From the Latin ‘*ambiguus*’ (adj.)= ‘questionable’; because of the unclear assignment of the species.

Type material

Holotype

IRAN – East Azerbaijan • Ali Bashi 4; *Paratirolites* Limestone (1.50 m below top) of the Ali Bashi Formation (late Changhsingian); 2011; Korn *et al.* leg.; illustrated in Fig. 28; MB.C.32055.

Table 16. Conch dimensions (in mm) and ratios of *Alibashinautilus ambiguus* gen. et sp. nov.

| Nr. | dm | ww | wh | uw | ah | ww/dm | ww/wh | uw/dm | WER | IZR |
|------------|-------|------|------|------|------|-------|-------|-------|------|------|
| MB.C.32055 | 120.3 | 43.1 | 42.7 | 44.3 | 41.0 | 0.36 | 1.01 | 0.37 | 2.30 | 0.04 |
| MB.C.32055 | 79.3 | 30.8 | 31.1 | 26.5 | – | 0.39 | 0.99 | 0.33 | – | – |

Description

Holotype MB.C.32055 has a conch diameter of 120 mm and suffered from some corrosion (Fig. 28B). However, it allows the study of the conch shape and proportions across one volution. The whorl profile is nearly circular with a very small overlap upon the preceding volution (Fig. 28A). There is no sculpture visible; the conch appears to be smooth. Almost the entire specimen is chambered; the suture line is almost straight. Despite of corrosion, it is clear that there are no ribs or other sculpture.

Remarks

Alibashinautilus ambiguus gen. et sp. nov. is distinguished from *A. vetus* gen. et sp. nov. by the lack of ribs on the outer flank. Other differences are the narrower umbilicus ($uw/dm \sim 0.37$ in *A. ambiguus*, but ~ 0.50 in *A. vetus*) and the higher coiling rate (WER ~ 2.30 in *A. ambiguus* in contrast to ~ 1.85 in *A. vetus*).

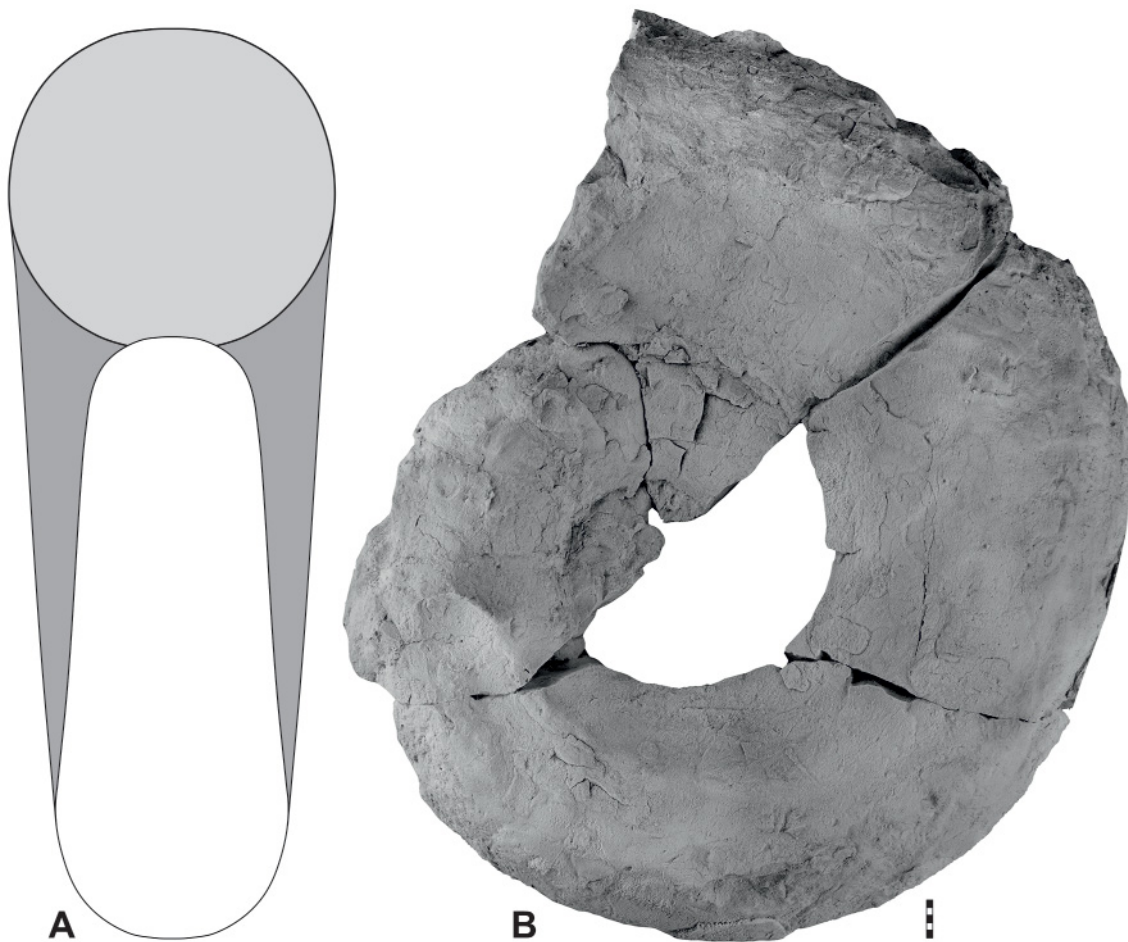

Fig. 28. *Alibashinautilus ambiguus* gen. et sp. nov., holotype MB.C.32055 (Korn *et al.* 2011 Coll.) from the *Paratirolites* Limestone (1.50 m below top) of the Ali Bashi Formation at Ali Bashi 4. **A.** Reconstruction of apertural view. **B.** Lateral view. Scale bar units = 1 mm.

Alibashinautilus sp.

Fig. 29

Material examined

IRAN – **West Azerbaijan** • 1 specimen; Aras Valley; *Araxoceras* Beds of the Julfa Formation (early Wuchiapingian); 2018; Ghaderi leg.; illustrated in Fig. 29; MB.C.32056.

Description

Specimen MB.C.32056 is a body chamber fragment (Fig. 29A) with a whorl height of 30 mm and a whorl width of 26 mm. The whorl profile is almost perfectly oval and is only influenced by a very small whorl overlap zone (Fig. 29B). The specimen shows quite coarse and broadly rounded, straight ribs on the flank.

Remarks

The single specimen most probably represents an own, independent species, but its fragmentary preservation does not provide sufficient data for a clear characterisation. It is thus kept in open nomenclature.

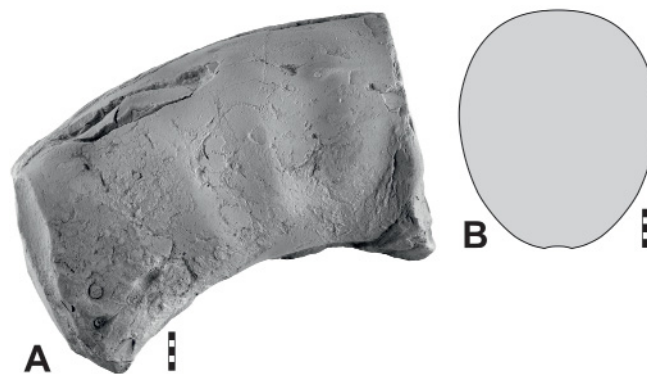

Fig. 29. *Alibashinautilus* sp., specimen MB.C.32056 (Ghaderi 2018 Coll.) from the *Araxoceras* Beds of the Julfa Formation at Aras Valley. **A.** Lateral view. **B.** Whorl profile. Scale bar units = 1 mm.

Family **Foordiceratidae** Korn, 2025

Diagnosis

Family of the superfamily Tainoceratoidea with a trapezoidal whorl profile; ventrolateral shoulder rounded, flanks strongly divergent. Sculpture with ventrolateral conical nodes, sometimes with low ribs on the flank. Suture line with shallow lobes and low saddles. Internal lobe very shallow, without annular process (from Korn 2025).

Included genera

Foordiceras Hyatt, 1893 (Permian); *Araxonautilus* Shimansky, 1979 (Permian); *Tardunautilus* gen. nov. (Permian).

Remarks

A detailed discussion of *Foordiceras* and genera with similar morphology has been given by Korn (2025).

Genus *Tardunautilus* gen. nov.

urn:lsid:zoobank.org:act:A29DB483-82CF-4C67-AC41-D6FBE9C79244

New genus E – Korn 2025: 56.

Type species

Tardunautilus nimius gen. et sp. nov.

Diagnosis

Genus of the family Foordiceratidae with evolute conch; whorl profile rounded triangular or rounded trapezoidal, depressed with broadly rounded venter. Sculpture with one or two rows of conical ribs near the ventrolateral shoulder. Suture line with very shallow external lobe and broadly rounded lateral lobe; without annular process.

Etymology

From the Latin ‘*tardus*’ (adj., m.)= ‘slow’; because of the low coiling rate of the conch, and ‘*nautilus*’ because of the relationship.

Included species

NW Iran (this paper): *Tardunautilus nimius* gen. et sp. nov., Wuchiapingian; *Tardunautilus minor* gen. et sp. nov., Wuchiapingian.

Central Iran (Korn & Hairapetian in press): new species J to be described by Korn & Hairapetian (in press), Wuchiapingian.

Remarks

The new genus can be easily distinguished from all other genera in the assemblage of Julfa because of its combination of a conch shape with a wide umbilicus, a rounded triangular or rounded trapezoidal whorl profile and a sculpture consisting of conical nodes. A genus with a similar morphology is *Pseudotemnocheilus*, but this is mostly known from much smaller specimens of about 40–60 mm in diameter. These smaller specimens have a much narrower umbilicus (uw/dm ~0.40) compared to *Tardunautilus* gen. nov. (uw/dm ~0.47) and a less depressed whorl profile (ww/wh ~1.30) than *Tardunautilus* (ww/wh ~1.40–1.80). The coiling rate is much lower in *Tardunautilus* (WER below 2.00) when compared to *Pseudotemnocheilus* (WER greater than 2.25).

Tardunautilus nimius gen. et sp. nov.

urn:lsid:zoobank.org:act:6A04A10E-B527-425A-8438-848513FDD2E5

Figs 30–31; Table 17

Diagnosis

Species of *Tardunautilus* gen. nov. with thickly discoidal, evolute conch (ww/dm ~0.53; uw/dm ~0.47), moderately depressed whorl profile (ww/wh ~1.80) and moderately high coiling rate (WER ~1.95) at a conch diameter of 150 mm. Whorl profile rounded trapezoidal with strongly divergent flanks; venter broadly rounded, area of flanks and umbilical wall weakly concave. Sculpture with two rows of ventrolateral nodes in the intermediate growth stage. Suture line with very broad and shallow external lobe, slightly deeper, broadly rounded lateral lobe and broadly rounded internal lobe.

Etymology

From the Latin ‘*nimius*’ (adjective, m.)= ‘very large’; because of the large size of the conch.

Table 17. Conch dimensions (in mm) and ratios of *Tardunautilus nimium* gen. et sp. nov.; estimated values in italics.

| Nr. | dm | ww | wh | uw | ah | ww/dm | ww/wh | uw/dm | WER | IZR |
|------------|--------------|------|------|-------------|------|-------------|-------|-------------|-------------|------|
| MB.C.32057 | <i>148.0</i> | 78.5 | 43.8 | <i>70.0</i> | 42.5 | <i>0.53</i> | 1.79 | <i>0.47</i> | <i>1.97</i> | 0.03 |

Type material

Holotype

IRAN – **East Azerbaijan** • Zal; Zal Member of the Ali Bashi Formation (early Changhsingian); 2018; Ghaderi leg.; illustrated in Fig. 30–31; MB.C.32057.

Description

The single holotype MB.C.32057 is a fragment consisting of about a quarter of two volutions; the reconstructed diameter of the specimen is approximately 148 mm (Fig. 30). The reconstructed conch is thickly discoidal and evolute ($ww/dm \sim 0.53$; $uw/dm \sim 0.47$). The whorl profile is moderately depressed ($ww/wh \sim 1.80$) and rounded trapezoidal with a broadly convex venter, a pronounced ventrolateral shoulder and a slightly concave zone consisting of flanks and umbilical wall; the whorl overlap is very small (Fig. 31A–B). It appears that the last preserved whorl slowly detaches from the preceding whorl. The profile of the penultimate whorl shows a more flattened venter, a more pronounced ventrolateral shoulder and flattened flanks.



Fig. 30. *Tardunautilus nimius* gen. et sp. nov., holotype MB.C.32057 (Ghaderi 2018 Coll.) from the *Araxoceras* Beds of the Julfa Formation at Aras Valley, lateral view. Scale bar units=1 mm.

The sculpture is well-preserved on the penultimate whorl. It consists of paired conical nodes on the flank; one row of nodes is located in the midflank area and the other row has a position on the ventrolateral shoulder. The nodes of each pair are connected by a low rib. Six of these node pairs occur on a quarter revolution. On the last whorl, no nodes are visible.

The suture line extends with a very shallow external lobe, a broadly rounded and shallow lateral lobe and a rounded internal lobe (Fig. 31C). The chambers are rather short; the septa are arranged in distances of about 14 degrees. The siphuncle has a dorsocentral position near the centre of the septum.

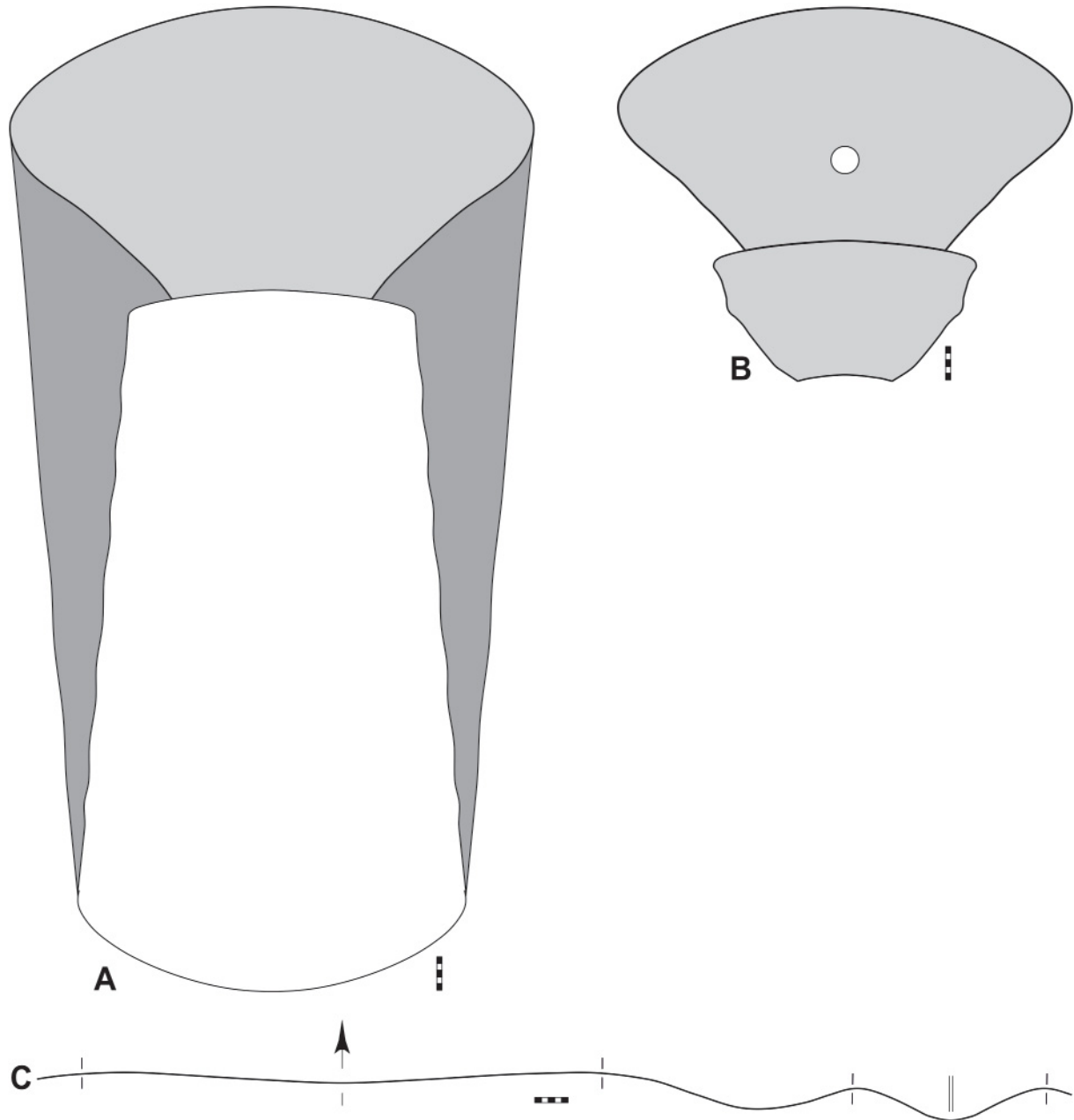

Fig. 31. *Tardunautilus nimius* gen. et sp. nov., holotype MB.C.32057 (Ghaderi 2018 Coll.) from the *Araxoceras* Beds of the Julfa Formation at Aras Valley. **A.** Reconstruction of apertural view. **B.** Whorl profiles 90 degrees before preserved aperture. **C.** Suture line at $ww=78.0$ mm, $wh=48.0$ mm. Scale bar units=1 mm.

Remarks

Tardunautilus nimius gen. et sp. nov. differs from *T. minor* gen. et sp. nov. in the presence of two rows of conical nodes on the flank, while *T. minor* has only one such row on the ventrolateral shoulder. Furthermore, the whorl profile is much more depressed in *T. nimius* (ww/wh ~1.80) than in *T. minor* (ww/wh ~1.50).

Tardunautilus minor gen. et sp. nov.

urn:lsid:zoobank.org:act:53ABF019-1677-4279-9A74-1193AA170FB6

Fig. 32; Table 18

Diagnosis

Species of *Tardunautilus* gen. nov. with thinly discoidal, evolute conch (ww/dm ~0.40; uw/dm ~0.47), weakly depressed whorl profile (ww/wh ~1.40) and moderately high coiling rate (WER ~1.85) at a conch diameter of 70 mm. Whorl profile rounded triangular with strongly divergent flanks; venter broadly rounded, area of flanks and umbilical wall flattened. Sculpture with one row of ventrolateral nodes in the intermediate growth stage. Suture line with a broad and shallow external lobe, and a broadly rounded lateral lobe.

Etymology

From the Latin ‘*minor*’ (noun)= ‘the smaller’; because of the small size of the conch.

Type material

Holotype

IRAN – East Azerbaijan • Kuh-e-Ali Bashi; *Araxoceras* Beds of the Julfa Formation (early Wuchiapingian); 2011; Korn *et al.* leg.; illustrated in Fig. 32; MB.C.32058.

Description

Holotype MB.C.32058 is a whorl segment of about 120 degrees and consists of the last phragmocone chamber and a longer part of the body chamber (Fig. 32B). The diameter of the evolute specimen may

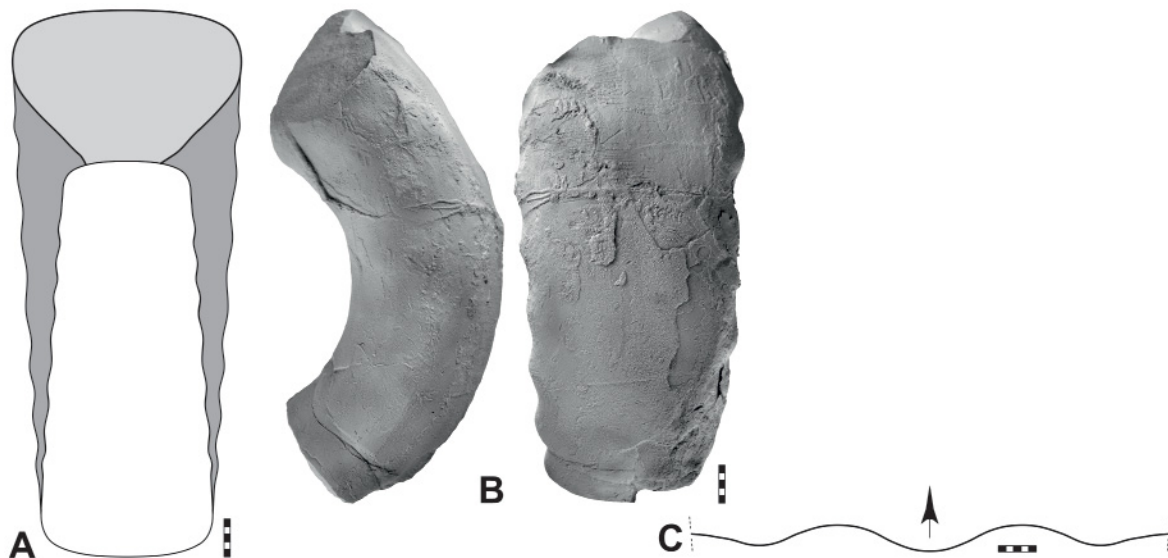

Fig. 32. *Tardunautilus minor* gen. et sp. nov., holotype MB.C.32058 (Korn *et al.* 2011 Coll.) from the *Araxoceras* Beds of the Julfa Formation at Ali Bashi. **A.** Reconstruction of apertural view. **B.** Lateral and ventral views. **C.** Suture line at ww=22.0 mm, wh=16.3 mm. Scale bar units=1 mm.

Table 18. Conch dimensions (in mm) and ratios of *Tardunautilus minor* gen. et sp. nov.; estimated values in italics.

| Nr. | dm | ww | wh | uw | ah | ww/dm | ww/wh | uw/dm | WER | IZR |
|------------|------|------|------|------|------|-------|-------|-------|------|------|
| MB.C.32058 | 72.5 | 30.5 | 20.5 | 34.0 | 19.0 | 0.42 | 1.49 | 0.47 | 1.84 | 0.07 |

have been about 72 mm. The depressed whorl profile ($ww/wh=1.42$) has a triangular outline with a broadly arched venter and a rounded ventrolateral shoulder from which the flattened flanks converge towards the umbilical seam. The imprint zone is very small (Fig. 32A).

In the whorl segment, there are eight conical nodes located on the ventrolateral shoulder. The suture line shows a wide and shallow external lobe, a broadly rounded ventrolateral saddle and a broadly rounded lateral lobe, which is slightly smaller than the external lobe (Fig. 32C).

Remarks

Tardunautilus minor gen. et sp. nov. differs from *T. nimius* gen. et sp. nov. in the presence of only one row of conical nodes on the ventrolateral shoulder, while *T. nimius* has two rows, which are located on the outer flank and the ventrolateral shoulder. Furthermore, the whorl profile is much less depressed in *T. minor* ($ww/wh \sim 1.50$) than in *T. nimius* ($ww/wh \sim 1.80$).

Family **Pleuronautilidae** Hyatt, 1900

Diagnosis

Family of the superfamily Pleuronautiloidea with a commonly subquadrate or weakly depressed whorl profile; venter ranging from convex to weakly concave, ventrolateral shoulder and umbilical margin often pronounced, flanks usually weakly convergent. Sculpture with numerous ribs on the flank, sometimes with conical tubercles and more rarely with spiral ridges. An annular process is present in the advanced species (from Korn 2025).

Included genera

New genus C to be described by Korn & Hairapetian (in press) (Permian); *Pleuronautilus* Mojsisovics, 1882 (Triassic); *Phloioceras* Hyatt, 1884 (Triassic); *Anoploceras* Hyatt, 1900 (Triassic); *Encoiloceras* Hyatt, 1900 (Triassic); *Enoploceras* Hyatt, 1900 (Triassic); *Holconautilus* Mojsisovics, 1902 (Triassic); *Trachynautilus* Mojsisovics, 1902 (Triassic); *Sibyllonautilus* Diener, 1915 (Triassic); *Phaedrysmocheilus* Shimansky & Erlanger, 1955 (Triassic); *Arctonautilus* Sobolev, 1989 (Triassic); *Grumantoceras* Sobolev, 1989 (Triassic).

Remarks

A detailed discussion of the Pleuronautilidae and families with similar morphology has been given by Korn (2025).

New genus C Korn & Hairapetian (in press)

Type species

New species K to be described by Korn & Hairapetian (in press); original designation.

Diagnosis

Genus of the family Pleuronautilidae with subevolute conch; whorl profile inverted trapezoidal, weakly depressed or equidimensional with broadly rounded venter, parallel or weakly convergent flanks, rounded

umbilical margin and convex or flattened umbilical wall. Sculpture with ribs on the flanks, without nodes or tubercles. Suture line with very shallow external lobe and broadly rounded lateral lobe; without annular process (from Korn & Hairapetian in press: 38).

Included species

Central Iran (Korn & Hairapetian in press): new species K to be described by Korn & Hairapetian (in press), Wuchiapingian; new species L to be described by Korn & Hairapetian (in press), Wuchiapingian; new species M to be described by Korn & Hairapetian (in press), Wuchiapingian.

Remarks

The new genus C will be introduced by Korn & Hairapetian (in press) for Permian species with a conch shape and sculpture similar to some Triassic species of *Pleuronautilus*, such as *P. mosis* Mojsisovics, 1882. The main difference, however, is that the new genus does not possess the annular process that is present in *Pleuronautilus*.

Other Late Permian species from other regions may also belong to the new genus. This is particularly true for the species from the Salt Range and southern China, which are usually classified as *Metacoceras* or *Pleuronautilus*. However, this will have to be verified based on the original material as part of a revision.

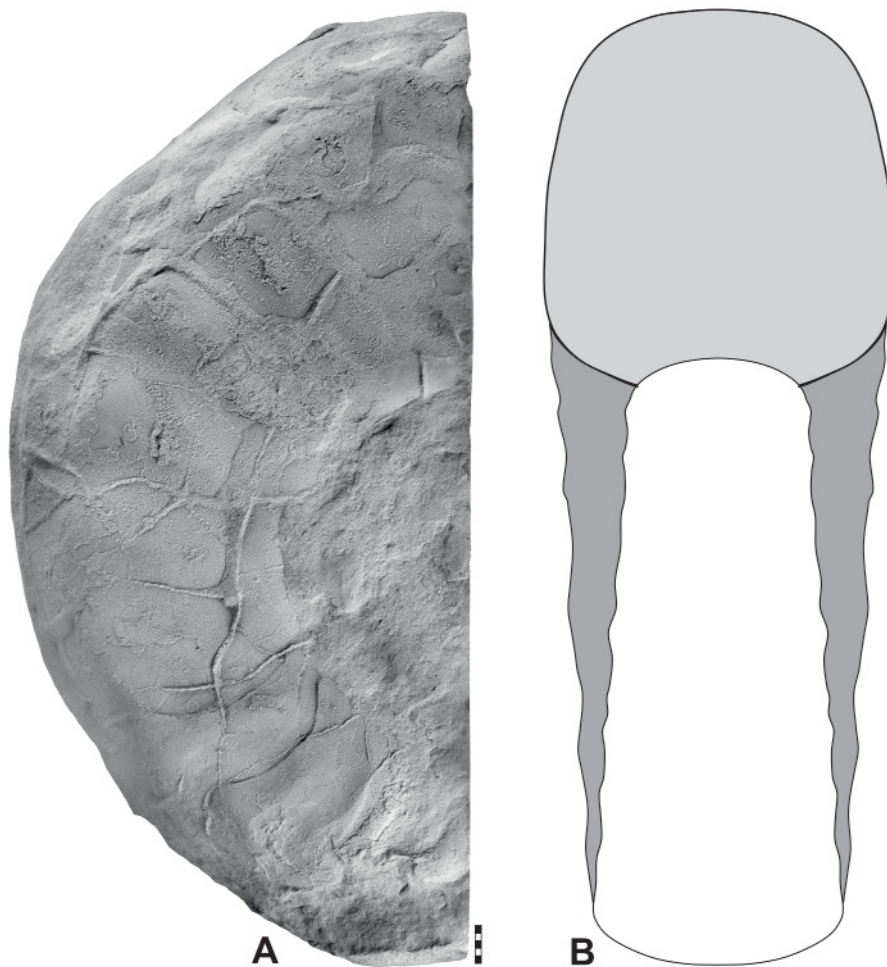

Fig. 33. New genus C to be described by Korn & Hairapetian (in press) sp., specimen MB.C.32059 (Ghaderi 2018 Coll.) from the Zal Member of the Ali Bashi Formation at Zal. **A.** Lateral view. **B.** Reconstruction of apertural view. Scale bar units = 1 mm.

New genus C Korn & Hairapetian (in press) sp.
Fig. 33; Table 19

Material examined

IRAN – **East Azerbaijan** • 1 specimen; Zal; Zal Member of the Ali Bashi Formation (early Changhsingian); 2018; Ghaderi leg.; illustrated in Fig. 33; MB.C.32059.

Description

Specimen MB.C.32059 is a fragment of a conch with a diameter of about 125 mm (Fig. 33A). It is vertically distorted and only allows the study from one side; the conch dimensions and ratio can only be estimated. It bears a coarse sculpture consisting of eleven rounded ribs on half a volution. These ribs extend with a concave sinus across the flank; they are particularly strongly developed in the ventrolateral region.

Remarks

The single fragmentary specimen does not provide sufficient data for a clear characterisation. It is thus kept in open nomenclature.

Table 19. Estimated conch dimensions (in mm) and ratios of the new genus C sp.

| Nr. | dm | ww | wh | uw | ah | ww/dm | ww/wh | uw/dm | WER | IZR |
|------------|-----|----|----|----|----|-------|-------|-------|------|------|
| MB.C.32059 | 125 | 46 | 48 | 45 | 42 | 0.37 | 0.96 | 0.36 | 2.27 | 0.13 |

Superfamily **Tainoceratoidea** Hyatt, 1883

Diagnosis

Superfamily of the suborder Tainoceratina with a discoidal to pachyconic, subinvolute or subevolute conch. Whorl profile always with midventral longitudinal groove; in early species subquadrate with a distinct ventrolateral shoulder and a distinct umbilical margin, in derived species polygonal with divergent or convergent flanks. Dorsal whorl zone always very small. Sculpture with rows of ventrolateral nodes, in some species with rows of nodes on the flank. Septa simply domed; suture line depending on the whorl profile, usually with shallow lobes and low saddles (from Korn 2025).

Included family

Tainoceratidae Hyatt, 1883 (Carboniferous to Triassic).

Remarks

A detailed discussion of superfamily Tainoceratoidea has been given by Korn (2025).

Family **Tainoceratidae** Hyatt, 1883

Diagnosis

Family of the superfamily Tainoceratoidea with a discoidal to pachyconic, subinvolute or subevolute conch. Whorl profile always with midventral longitudinal groove; in early species subquadrate with a distinct ventrolateral shoulder and a distinct umbilical margin, in derived species polygonal with divergent or convergent flanks. Dorsal whorl zone always very small. Sculpture with rows of ventrolateral

nodes, in some species with rows of nodes on the flank. Septa simply domed; suture line depending on the whorl profile, usually with shallow lobes and low saddles (from Korn 2025).

Included genera

Tainoceras Hyatt, 1883 (Carboniferous to Permian); *Tainionutilus* Mojsisovics, 1902 (Permian to Triassic); *Tirolonutilus* Mojsisovics, 1902 (Permian); *Tylonutilus* Pringle & Jackson, 1928 (Carboniferous to ?Permian); *Aulametacoceras* Miller & Unklesbay, 1942 (Permian); *Hexagonites* Hayasaka, 1947 (Permian); *Hunanoceras* Chao, 1954 (Permian); *Hefengnutilus* Xu, 1977 (Permian); *Clavinutilus* Zhao, Liang & Zheng, 1978 (Permian); *Eulomacoceras* Zhao, Liang & Zheng, 1978 (Permian); *Lirometacoceras* Zhao, Liang & Zheng, 1978 (Permian); *Neotainoceras* Zhao, Liang & Zheng, 1978 (Permian); *Parataionutilus* Zhao, Liang & Zheng, 1978 (Permian); *Seironutilus* Zhao, Liang & Zheng, 1978 (Permian); *Neoclavinutilus* Liang, 1984 (Permian); *Nodonutilus* Liang, 1984 (Permian); *Nodopleuroceras* Zheng, 1984 (Permian); *Meixianlingites* Qin, 1986 (Permian); *Parataionoceras* Qin, 1986 (Permian); *Siamnutilus* Ishibashi *et al.*, 1994 (Permian); *Gujiaonutilus* Miao *et al.*, 2019 (Permian); new genus D to be described by Korn & Hairapetian (in press) (Permian); *Corotainoceras* gen. nov. (Permian).

Remarks

A detailed discussion of family Tainoceratidae has been given by Korn (2025).

Genus *Tainoceras* Hyatt, 1883

Type species

Nautilus quadrangulus McChesney, 1860; original designation.

Diagnosis

Genus of the family Tainoceratidae with a subinvolute or subevolute conch; whorl profile more or less strongly depressed, ranging from subquadrate and hexagonal to polygonal with a distinct midventral longitudinal groove. Umbilical margin usually pronounced and subangular in the intermediate stage, rounded in the adult stage. Sculpture usually with two rows of conical nodes on the venter and additional rows on the flank. Septa simply domed, suture line strongly depending on the shape of the whorl profile, usually with shallow external lobe and broadly rounded lateral lobe. Siphuncle small with subcentral position ventrad of septum centre.

Included Carboniferous species

North America (McChesney 1860; Miller *et al.* 1933; Miller & Unklesbay 1942; Lintz 1958; Tucker & Mapes 1978; Sturgeon *et al.* 1982): *Nautilus quadrangulus* McChesney, 1860, Gzhelian, Illinois; *Nautilus nodocarinatus* McChesney, 1860, Gzhelian, Illinois; *Tainoceras monilifer* Miller, Dunbar & Condra, 1933, Gzhelian, Texas; *Tainoceras rotundatum* Miller, Dunbar & Condra, 1933, Gzhelian, Texas; *Tainoceras murrayi* Miller & Unklesbay, 1942, Gzhelian, Nebraska; *Metacoceras marylandica* Lintz, 1958, Gzhelian, Maryland; *Tainoceras sexlineatum* Tucker, 1976, Kasimovian, Illinois; *Tainoceras collinsi* Sturgeon, Windle, Mapes & Hoare, 1982, Gzhelian, Ohio.

Donets Basin (Dernov 2024): *Tainoceras luxaeterna* Dernov, 2024, Kasimovian.

Western Russia (Waagen 1879): *Nautilus Trautscholdi* Waagen, 1879, Gzhelian, Moscow Basin.

Included Permian species

North America (Swallow 1860; Hyatt 1891, 1893; Miller *et al.* 1933; Miller & Thomas 1936; Miller & Unklesbay 1942; Miller & Kemp 1947; Miller & Youngquist 1949): *Nautilus occidentalis* Swallow, 1860, Artinskian, Kansas; *Tainoceras cavatum* Hyatt, 1891, Asselian, Texas; *Tainoceras Duttoni* Hyatt, 1893, Asselian, New Mexico; *Tainoceras nebrascense* Miller, Dunbar & Condra, 1933, Artinskian, Nebraska; *Tainoceras wyomingense* Miller & Thomas, 1936, Asselian, Wyoming; *Tainoceras schellbachi* Miller & Unklesbay, 1942, Kungurian, Arizona; *Tainoceras clydense* Miller & Kemp, 1947, Kungurian, Texas; *Tainoceras unklesbayeri* Miller & Youngquist, 1949, Kungurian, Texas.

Alps and Southern Europe (Gemmellaro 1889; Simić 1933; Schréter 1974; Prinoth & Posenato 2007): *Pleuonautilus Toulai* Gemmellaro, 1890, Wordian, Sicily; *Tainoceras zmajevata* Simić, 1933, Wuchiapingian, Serbia; *Tainoceras bükkense* Schréter, 1974, Changhsingian, Bükk Mountains; *Tainoceras crassicoatum* Schréter, 1974, Changhsingian, Bükk Mountains; *Tainoceras balestense* Prinoth & Posenato, 2007, Changhsingian, Dolomites; *Tainoceras malsineri* Prinoth & Posenato, 2007, Changhsingian, Dolomites.

NW Iran (this paper): *Tainoceras admonens* sp. nov., Wuchiapingian; *Tainoceras latecostatum* sp. nov., Wuchiapingian; *Tainoceras unitum* sp. nov., Changhsingian.

Central Iran (Korn & Hairapetian in press): new species N to be described by Korn & Hairapetian (in press), Changhsingian, Central Iran.

Pakistan (Reed 1931, 1944): *Tainoceras Noetlingi* var. *subglobosa* Reed, 1931, Wuchiapingian, Salt Range; *Tainoceras comptum* Reed, 1944, Changhsingian, Salt Range; *Tainoceras debile* Reed, 1944, Changhsingian, Salt Range; *Tainoceras trimuense* Reed, 1944, Wuchiapingian, Salt Range.

South China (Kayser 1883; Chao 1954; Zheng 1984): *Nautilus mingshanensis* Kayser, 1883, Wuchiapingian, Jiangxi; *Nautilus orientalis* Kayser, 1883, Wuchiapingian, Jiangxi; *Tainoceras changlingpuense* Chao, 1954, Roadian, Hunan; *Tainoceras hunanense* Chao, 1954, Roadian, Hunan; *Tainoceras gibbosum* Zheng, 1984, Changhsingian, Guizhou; *Tainoceras guizhouense* Zheng, 1984, Changhsingian, Guizhou; *Tainoceras lateronodosum* Zheng, 1984, Changhsingian, Guizhou.

Japan (Hayasaka 1957, 1962; Ehiro & Araki 1997): *Tainoceras abukumense* Hayasaka, 1957, Capitanian; *Tainoceras kitakamiense* Hayasaka, 1962, Roadian; *Tainoceras carinatum* Ehiro & Araki, 1997, Capitanian.

Remarks

Tainoceras is the typical representative of the family, superfamily and suborder named after it and is considered one of the cardinal genera within the order Nautilida. About 40 species of *Tainoceras* have been described so far and the genus has a long stratigraphic range extending from the latest Carboniferous to the latest Permian. However, only a few efforts have been made to clearly define the genus in its morphological range. While Miller *et al.* (1933: 147) and Miller & Youngquist (1949: 80) gave a detailed characterisation of the genus, Shimansky (1962b: 121) and Kummel (1964: K413) characterised the genus *Tainoceras* with just one sentence: "Like *Metacoceras* but with a double row of nodes on the venter." Sturgeon *et al.* (1997: 29) were more precise: "Similar to *Metacoceras* but possessing two ventral rows of nodes or ribs separated by a median sulcus." They gave a more detailed outline of the characters typically present in *Tainoceras*.

It is apparent that a simple definition is not adequate to define the rather complex genus, especially in respecting the fact that other tainoceratid genera have been established in recent decades. A precise

morphological delineation and taxonomic interpretation of *Tainoceras* requires a discussion of several questions:

- (1) What are the morphological characters that can be used to clearly distinguish *Tainoceras* from other genera?
- (2) Are the tainoceratids (*Tainoceras* and derived genera of the Late Permian) really a monophyletic unit?
- (3) Did long-ranging evolutionary lineages with stable morphology exist within *Tainoceras*, or did similar conch shapes and sculptures emerge iteratively and independently?

The first question is not easy to answer. The previously used character of a double row of ventral nodes cannot be used universally as a cardinal separating character because some species have only one row of ventral nodes or no ventral nodes at all in the adult stage (e.g., the Late Carboniferous *T. collinsi* and *T. marylandicum* and the Late Permian *T. balestense*). Instead, other supporting characters, such as the presence of the midventral groove, must be used. It should be made clear that in *Tainoceras* this groove incurves a broadly rounded venter. This is in contrast to genera such as *Metacoceras*, in which a concave venter, if present at all, always occurs as a shallow depression of the entire venter.

The second question is easier to answer. Although the morphological spectrum of *Tainoceras* is rather broad and somewhat variable, the combination of several morphological characters, such as the presence of the midventral groove, the rows of nodes on the venter and ventrolateral shoulder and the pronounced umbilical margin, suggests a monophyletic series of forms. Due to the complexity of the morphology, a polyphyletic origin of *Tainoceras* can be excluded.

To answer the third question, it is necessary to evaluate the characters of conch geometry and sculpture with regard to their variation within the genus *Tainoceras*. The following characters have proven to be particularly variable (with some representative examples):

- General shape of the whorl profile: it can range from rectangular (*T. nebrascense*) to octagonal or polygonal (*T. clydense*, *T. admonens* sp. nov.); the ww/wh ratio can range from approximately equidimensional (*T. cavatum*) to weakly depressed (*T. schellbachi*, *T. admonens* sp. nov.) and moderately depressed (*T. duttoni*).
- General shape of the venter: in all of the species, the venter is more or less tripartite, but the degree of tripartition varies from weak with nearly convex venter (*T. cavatum*) to very strong with clearly defined ventrolateral applanation forming a tectiform venter (*T. clydense*, *T. duttoni*).
- Arrangement and shape of the flanks: the flanks can be divergent (*T. quadrangulum*, *T. admonens* sp. nov.), parallel (*T. quadrangulum*) or convergent (*T. duttoni*). They can be flattened (*T. cavatum*) or weakly concave (*T. duttoni*, *T. admonens*).
- Shape of the umbilical margin and umbilical wall: while the umbilical margin is usually narrowly rounded (*T. nebrascense*) or subangular (*T. duttoni*), the umbilical wall ranges from oblique (*T. cavatum*, *T. clydense*) to steep (*T. duttoni*) and from weakly convex (*T. nebrascense*) to flattened (*T. duttoni*, *T. admonens* sp. nov.).
- Width and depth of the midventral groove: the groove can vary from narrow (*T. nebrascense*, *T. clydense*) to wide (*T. schellbachi*, *T. admonens* sp. nov.) and from shallow (*T. collinsi*, *T. cavatum*, *T. admonens*) to deep (*T. duttoni*, *T. wyomingense*).
- Formation of the ventral nodes: ventral sculptural elements may appear as short plications (*T. collinsi*), small tubercles (*T. nebrascense*, *T. monilifer*, *T. nodocarinatum*, *T. admonens* sp. nov.), or also large conical, blunt nodes (*T. clydense*) or pointed nodes or spines (*T. quadrangulum*, *T. schellbachi*). Some species possess coarse ventral transverse ribs (*T. unklesbayi*). The ventral tubercles may be arranged symmetrically (*T. nebrascense*) or alternating on the right and left sides of the midventral groove (*T. monilifer*).

- Formation of lateral ribs: lateral ribs do not occur in many of the North American species, but are present in species from other regions (*T. debile*, *T. admonens* sp. nov.).
- Formation of umbilical nodes: umbilical sculptural elements are present in some species; they range from being small tubercles (*T. clydense*) to large conical nodes (*T. schellbachi*).

The list of mostly bipolar character pairs shows numerous theoretically possible combinations; however, covariation is very common and some of the characters often appear simultaneously.

Tainoceras admonens sp. nov.

urn:lsid:zoobank.org:act:962E20FB-58E7-40B0-B125-55893A5F1495

Fig. 34; Table 20

Tainoceras (?) sp. – Gliwa *et al.* 2020: text-fig. 17c.

Diagnosis

Species of *Tainoceras* with thinly pachyconic, subevolute conch (ww/dm ~0.65; uw/dm ~0.32), weakly depressed whorl profile (ww/wh ~1.45) and extremely high coiling rate (WER ~2.85) at a conch diameter of 50 mm. Whorl profile polygonal with convergent flanks; venter tectiform with broad longitudinal midventral groove, flanks weakly concave, umbilical margin narrowly rounded. Sculpture with about 12 faint ribs on the flank per volution, strengthened to form small, longitudinally elongated tubercles on the ventrolateral shoulder. Suture line with a shallow, tongue-shaped external lobe and a broadly rounded, very shallow lateral lobe.

Etymology

From the Latin ‘*admonens*’ (verb in participle) = ‘reminding’; because of the similar conch geometry with the Late Carboniferous species of the genus.

Type material

Holotype

IRAN – **West Azerbaijan** • Aras Valley; *Vedioceras* Beds of the Julfa Formation (late Wuchiapingian); 2011; Korn *et al.* leg.; illustrated in Fig. 34D–F; MB.C.29348.

Paratype

IRAN – **West Azerbaijan** • 1 specimen; same data as for holotype; illustrated in Fig. 34A–C; MB.C.32060.

Description

Holotype MB.C.29348 is a partly corroded specimen, but nevertheless allows examination of the conch geometry, sculpture and suture line (Fig. 34D). It has a conch diameter of 48 mm and is fully chambered. The conch is thinly pachyconic and subevolute (ww/dm=0.65; uw/dm=0.32) with an extremely high coiling rate (WER=2.80) and a very small whorl overlap zone. The whorl profile is weakly depressed whorl profile (ww/wh=1.44) and polygonal with divergent, concave flanks; the umbilical margin is narrowly rounded and the umbilical wall is flattened. The ventrolateral shoulder is pronounced and subangular; it delimits the broad venter, which is rounded-tectiform in cross section and possesses three concave zones, of which the central is the deepest (Fig. 34E). The sculpture consists of faint, longitudinally elongated conical tubercles with a position on the ventrolateral shoulder. There are about 15 of such tubercles per volution. The venter bears one row of very low, blunt tubercles on each side adjacent to the longitudinal groove. These tubercles do not correspond to the riblets on the flank and are

more numerous. The suture line is undulated with very shallow lobes in the concave parts of the conch (Fig. 34F).

Paratype MB.C.32060 is a rather strongly corroded specimen, but nevertheless allows examination of the conch geometry, sculpture and suture line. It has a conch diameter of 56 mm and is fully chambered (Fig. 34A). The conch is thinly pachyconic and subevolute ($ww/dm=0.67$; $uw/dm=0.32$) with an extremely high coiling rate ($WER=2.89$) and a very small whorl overlap zone. The whorl profile is moderately depressed whorl profile ($ww/wh=1.50$) is generally rounded polygonal with slowly divergent, weakly concave flanks; the umbilical margin is narrowly rounded and the umbilical wall is flattened. The ventrolateral shoulder is pronounced and delimit the broad venter, which is convex in cross section, but possesses three concave zones, of which the central is the deepest (Fig. 34B). The sculpture consists of low, longitudinally elongated conical tubercles with a position on the ventrolateral shoulder. There are about 12 of such ribs per revolution. The venter bears one row of very low, barely visible nodes on both sides of the longitudinal groove. The suture line is undulated with very shallow lobes in the concave parts of the conch (Fig. 34C).

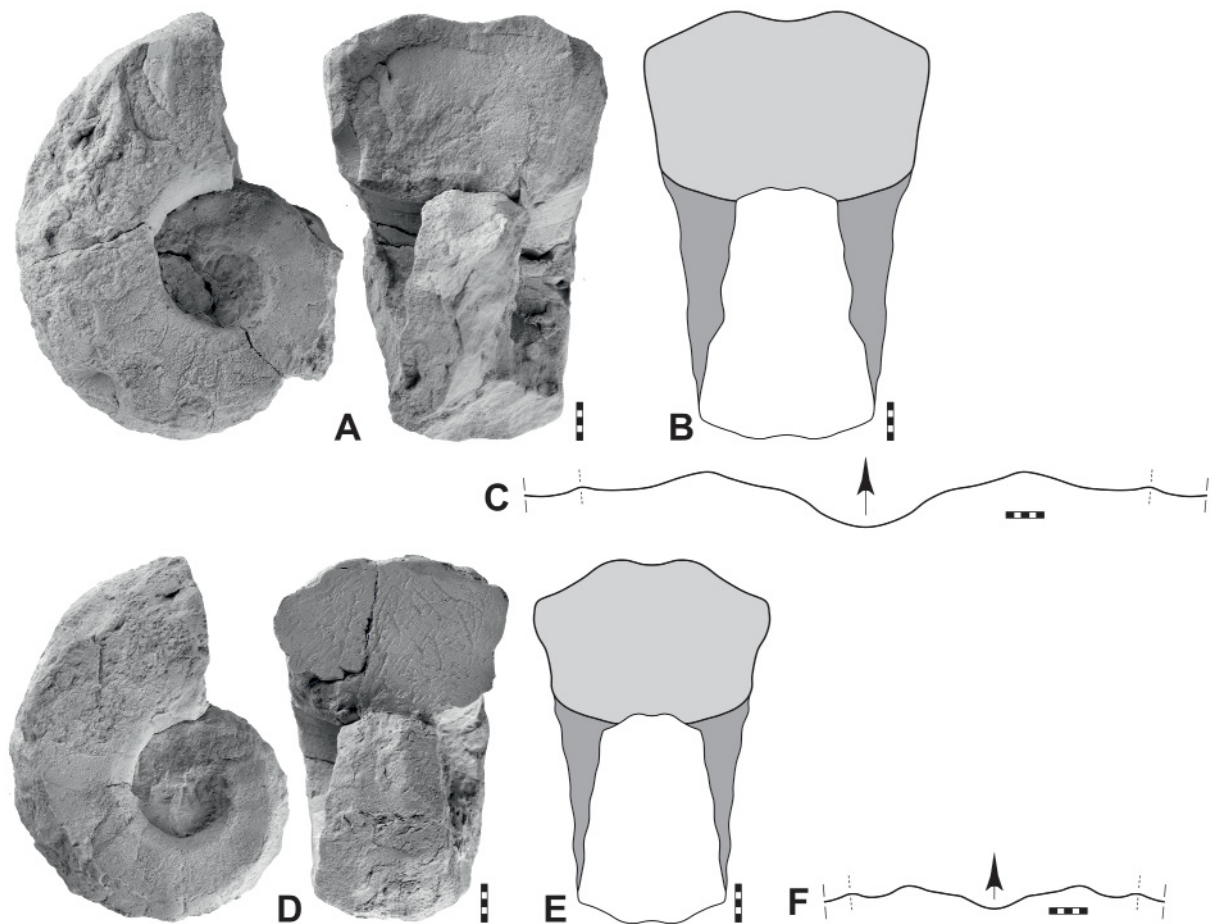

Fig. 34. *Tainoceras admonens* sp. nov. **A.** Paratype MB.C.32060 (Korn *et al.* 2011 Coll.) from the *Vedioceras* Beds of the Julfa Formation at Aras Valley, lateral and apertural views. **B.** The same specimen, reconstruction of apertural view. **C.** Suture line at $dm=57.5$ mm, $ww=36.0$ mm, $wh=22.6$ mm. **D.** Holotype MB.C.29348 (Korn *et al.* 2011 Coll.) from the *Vedioceras* Beds of the Julfa Formation at Aras Valley, lateral and apertural views. **E.** The same specimen, reconstruction of apertural view. **F.** Suture line at $dm=32.6$ mm, $ww=22.8$ mm, $wh=10.7$ mm. Scale bar units=1 mm.

Table 20. Conch dimensions (in mm) and ratios of *Tainoceras admonens* sp. nov.

| Nr. | dm | ww | wh | uw | ah | ww/dm | ww/wh | uw/dm | WER | IZR |
|------------|------|------|------|------|------|-------|-------|-------|------|------|
| MB.C.32060 | 56.4 | 37.6 | 25.0 | 17.9 | 23.2 | 0.67 | 1.50 | 0.32 | 2.89 | 0.07 |
| MB.C.32060 | 33.2 | 23.2 | 15.0 | 9.6 | – | 0.70 | 1.55 | 0.29 | – | – |
| MB.C.29348 | 48.0 | 31.2 | 21.6 | 15.5 | 19.3 | 0.65 | 1.44 | 0.32 | 2.80 | 0.11 |
| MB.C.29348 | 27.7 | 19.6 | 11.0 | 8.7 | – | 0.71 | 1.78 | 0.31 | – | – |

Remarks

Tainoceras admonens sp. nov. has, because of its very weak sculpture, a marginal position in the morphological spectrum of the genus. Particularly the weak ribs on the flank and the presence of only one row of ventral nodes distinguishes the new species from the others of the genus.

The general conch shape and the sculpture are similar to the stratigraphically older species of the genus, such as the Late Carboniferous type species *T. quadrangulum*, but the new species differs in the considerably weaker developed ventrolateral and ventral tubercles. The Early Permian *T. clydense* is more similar, especially in the non-corresponding ventral and ventrolateral tubercles. However, the ventral nodes in *T. clydense* are much higher than in *T. admonens* sp. nov. In addition, the umbilicus in *T. clydense* is narrower ($uw/dm \sim 0.25$) than in *T. admonens* ($uw/dm \sim 0.30$).

Tainoceras latecostatum sp. nov.

urn:lsid:zoobank.org:act:69764943-0130-453D-9EB0-B478EC4E6515

Fig. 35; Table 21

Diagnosis

Species of *Tainoceras* with discoidal, subevolute conch ($ww/dm \sim 0.45$; $uw/dm \sim 0.33$) and weakly depressed whorl profile ($ww/wh \sim 1.15$) at a conch diameter of about 100 mm. Whorl profile hexagonal with gently convergent flanks; venter tectiform with broad longitudinal midventral groove, flanks flattened, umbilical margin narrowly rounded. Sculpture with about 20 sharp, coarse ribs on the flank per volution; venter with one row of hump-like, low nodes adjacent to the longitudinal groove. Suture line with a rather deep, tongue-shaped external lobe and a broadly rounded lateral lobe.

Etymology

Combination of the Latin ‘late’ (adv.)=‘broadly’ and ‘costatum’ (adj., n.)=‘ribbed’; because of the coarse ribs on the flanks.

Type material**Holotype**

IRAN – **East Azerbaijan** • Ali Bashi 4; *Vedioceras* Beds of the Julfa Formation (late Wuchiapingian); 2018; Ghaderi leg.; illustrated in Fig. 35; MB.C.32061.

Description

Holotype MB.C.32061 is a fragment of a phragmocone with an estimated conch diameter of 95 mm (Fig. 35B). It is slightly tectonically distorted, but nevertheless allows the conch geometry to be recognised quite well; it can be estimated that the width of the umbilicus is about one third of the conch diameter. The whorl profile is weakly depressed with a whorl width of 45 mm and a whorl height of 39 mm; the venter is convex and has a median longitudinal groove with a width of about 12 mm. The weakly convergent flanks are flattened and bordered by a rounded ventrolateral shoulder and a rounded umbilical margin (Fig. 35A).

The sculpture consists of a combination of ribs and nodes. On the flank, five very strong ribs are present on a quarter of a volution; these begin at a short distance from the umbilical margin and extend in slight forward direction with a shallow lateral sinus across the flank. In the ventrolateral region they increase in strength and form sharp ridges ending in ventrolateral nodes. These continue a short distance towards the lateral side of the venter, where they are directed backwards. Very low and bluntly rounded hump-like conical nodes occur immediately adjacent to the median longitudinal groove; these nodes correspond to the ribs on the flanks. The suture line shows a tongue-shaped external lobe and a broadly rounded lateral lobe (Fig. 35C).

Remarks

A new species is established here, although only one fragmentary specimen is available. The reason for this is the peculiar sculpture of *Tainoceras latecostatum* sp. nov., which consists of a combination of ribs on the flanks and one row of very low, hump-like nodes on the venter. It is especially the coarse ribs that give the new species a unique position in the genus; other species possess conical nodes on the flanks instead.

In lateral view, with the narrowly rounded umbilical margin, the flattened flanks and the somewhat concave ribs, the new species bears some resemblance to the species of the genus *Serometacoceras* gen. nov., but differs in the ventral longitudinal groove and the ventral nodes.

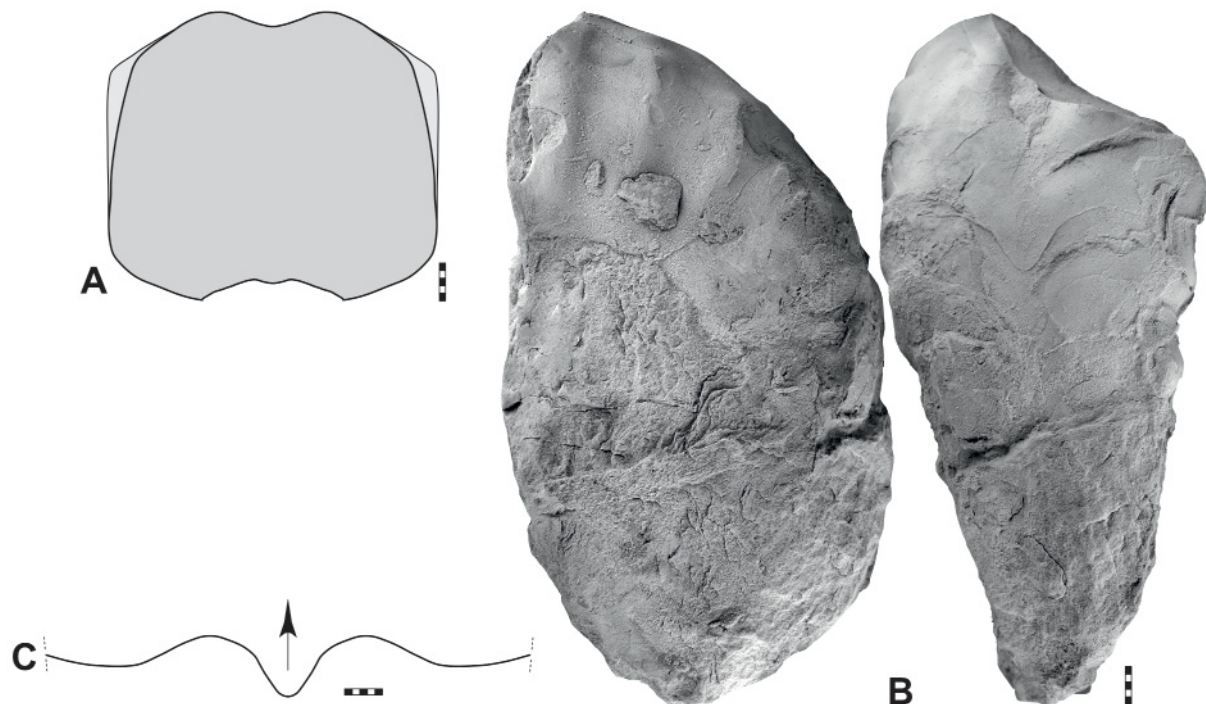

Fig. 35. *Tainoceras latecostatum* sp. nov., holotype MB.C.32061 (Ghaderi 2018 Coll.) from the *Vedioceras* Beds of the Julfa Formation at Ali Bashi 4. **A.** Whorl profile. **B.** The same specimen, lateral and ventral views. **C.** The same specimen, suture line at wh=27.0 mm. Scale bar units = 1 mm.

Table 21. Estimated conch dimensions (in mm) and ratios of *Tainoceras latecostatum* sp. nov.

| Nr. | dm | ww | wh | uw | ah | ww/dm | ww/wh | uw/dm | WER | IZR |
|------------|----|----|----|----|----|-------|-------|-------|-----|-----|
| MB.C.32061 | 95 | 45 | 39 | – | – | 0.47 | 1.15 | – | – | – |

Tainoceras unitum sp. nov.

urn:lsid:zoobank.org:act:1F60FF8F-3ABB-4B98-ABED-853626335165

Fig. 36

Diagnosis

Species of *Tainoceras* with thinly pachyconic, subevolute conch and nearly quadrate whorl profile (ww/wh ~ 1.10) at a conch diameter of about 80 mm. Whorl profile with weakly convergent flanks; venter flattened with a broad longitudinal midventral groove, flanks sinuous, umbilical margin narrowly rounded. Sculpture with five coarse ribs per quarter revolution, extending from the umbilical margin to the midventral groove, strengthened to form small, longitudinally elongated nodes on the ventrolateral shoulder and the venter. Suture line with a very shallow external lobe and a broadly rounded, very shallow lateral lobe.

Etymology

From the Latin ‘*unitum*’ (verb in participle) = ‘united’; because of the amalgamated ventrolateral and ventral nodes.

Type material**Holotype**

IRAN – **West Azerbaijan** • Zal; Zal Member of the Ali Bashi Formation (early Changhsingian); 2018; Ghaderi leg.; illustrated in Fig. 36; MB.C.32062.

Description

The fragmentary holotype MB.C.32062 has a whorl height of 30 mm and thus may belong to a specimen with a conch diameter of about 80 mm (Fig. 36A). Its whorl profile is almost quadrate but slightly depressed (ww/wh = 1.06) with narrowly rounded umbilical margin, flattened slowly converging flanks, rounded ventrolateral shoulders and a flattened venter with a shallow and broad longitudinal groove (Fig. 36B). The sculpture of the fragment shows five rounded ribs on the whorl segment of 90 degrees. These ribs are slightly concave in their course; they begin on the inner flanks and become more prominent to terminate in pronounced ventrolateral nodes, which have a position on the outer flank. On the venter, another row of nodes is present adjacent to the ventral groove. The ventrolateral and ventral nodes are corresponding and connected by a blunt rib. The suture line is weakly undulate with very shallow, broadly rounded external and lateral lobes (Fig. 36C).

Remarks

Tainoceras unitum sp. nov. has a similar conch shape and sculpture to that of *T. latecostatum* sp. nov., but differs in the blunt flank ribs (which are sharp in *T. latecostatum*) and the much thicker ventral nodes, which are very weakly developed in *T. latecostatum*. Another difference between the two species is the rib-like connection of the ventrolateral and ventral nodes in *T. unitum*, whereas these are separate in *T. latecostatum*.

Tainoceras unitum sp. nov. differs from many other species of the genus in the presence of flank ribs. In addition, the almost complete fusion of the ventrolateral and ventral nodes is not developed in the other species.

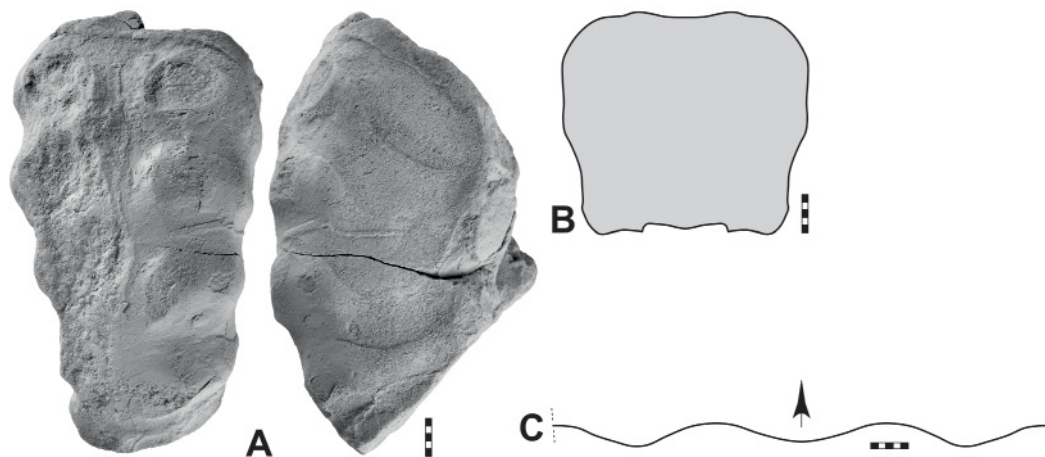

Fig. 36. *Tainoceras unitum* sp. nov., holotype MB.C.32062 (Ghaderi 2018 Coll.) from the Zal Member of the Ali Bashi Formation at Zal. **A.** Ventral and lateral views. **B.** Whorl profile. **C.** Suture line at $ww=26.5$ mm, $wh=26.0$ mm. Scale bar units = 1 mm.

New genus D Korn & Hairapetian (in press)

Type species

New species O to be described by Korn & Hairapetian (in press); original designation.

Diagnosis

Genus of the family Tainoceratidae with subinvolute or subevolute conch; whorl profile depressed and polygonal with a shallow or broad midventral longitudinal groove. Umbilical margin pronounced and narrowly rounded, flanks convergent. Sculpture with one row of nodes on the ventrolateral shoulder. Suture line strongly depending on the shape of the whorl profile, with rounded V-shaped external lobe and broadly rounded lateral lobe (from Korn & Hairapetian in press).

Included species

Transcaucasia (Abich 1878): *Nautilus dorso plicatus* Abich, 1878, Wuchiapingian, Azerbaijan.

Central Iran (Korn & Hairapetian in press): new species O to be described by Korn & Hairapetian (in press), Wuchiapingian.

Remarks

According to Korn & Hairapetian (in press), the new genus D is a genus with a morphology that is similar to that of some species of *Tainoceras*, but with a much less developed sculpture. In contrast to *Tainoceras*, which usually has two rows of nodes or tubercles in the ventrolateral region and sometimes another row of nodes on the inner flank, the new genus D has only one row of nodes, located on each side immediately adjacent to the median longitudinal groove, but lacks another row in the ventrolateral region. With a simplification of the sculpture, the new genus may be derived from *Tainoceras*. *Corotainoceras* also shows simplification of the sculpture, but differs from the new genus D in the absence of ventrolateral nodes and the presence of very coarse dorsolateral nodes.

New genus *D dorsoplicatum* (Abich, 1878)
Fig. 3A–B

Nautilus dorso plicatus Abich, 1878: 23, pl. 2 fig. 6, pl. 3 fig. 1, pl. 4 fig. 8.

Coelonautilus dorsoplicatus – von Arthaber 1900: 217.

Tainoceras dorsoplicatum – Shimansky 1965a: 41, pl. 14, fig. 1.

Remarks

Abich (1878) illustrated two fragments as “*Nautilus dorso plicatus*, nov. form.”. The first of these (Abich 1878: pl. 4 fig. 8) has a whorl height of about 27 mm. It shows rounded, strongly convergent flanks and a venter with a longitudinal midventral groove about 15 mm wide (Fig. 3B). This groove is bordered on both sides by a slightly raised margin that is decorated with large, blunt nodes. Ventrolateral nodes are obviously lacking. The suture line has a fairly narrow, rounded lobe on the venter and a broad, rounded lobe on the flank.

The second specimen (Abich 1878: pl. 2 fig. 3, pl. 3 fig. 1) has a whorl width of about 35 mm (Fig. 3A) and corresponds to the larger one in conch shape and sculpture. The specimen has a broadly rounded umbilical margin. It shows that there are neither ventrolateral nor umbilical nodes; the flank appears to be smooth.

New genus *D dorsoplicatum* occupies a morphologically isolated position in the family Tainoceratidae due to the presence of only a single row of ventral nodes. The species is probably not represented in the new collections from NW Iran.

Genus *Corotainoceras* gen. nov.

urn:lsid:zoobank.org:act:F415AD8C-A2F7-4191-809F-FDC1796B0974

New genus F – Korn 2025: 61.

Type species

Corotainoceras inerme gen. et sp. nov.

Diagnosis

Genus of the family Tainoceratidae with subevolute conch; whorl profile depressed and polygonal with a shallow midventral longitudinal groove. Umbilical margin broadly rounded, flanks convergent. Sculpture without nodes on the venter and the ventrolateral shoulder, but with coarse umbilical nodes. Suture line strongly depending on the shape of the whorl profile, with shallow, rounded V-shaped external lobe and broadly rounded lateral lobe.

Etymology

Combination of the Latin ‘*corona*’ (noun)=‘wreath’ and *Tainoceras*; because of the coronate umbilicus.

Included species

NW Iran (this paper): *Corotainoceras inerme* gen. et sp. nov., Wuchiapingian.

Remarks

The genera of the family Tainoceratidae are generally distinguished on the basis of their sculpture. The new genus differs from all other genera of the family in the absence of ventral and ventrolateral nodes or tubercles. In contrast to most other members of the family Tainoceratidae, the type species of *Corotainoceras* shows very coarse umbilical nodes.

Corotainoceras inerme gen. et sp. nov.

urn:lsid:zoobank.org:act:559DBF42-CD82-4777-8150-564C7FF44B50

Fig. 37; Table 22

Diagnosis

Species of *Corotainoceras* with thinly pachyconic, subevolute conch ($ww/dm \sim 0.62$; $uw/dm \sim 0.30$), weakly depressed whorl profile ($ww/wh \sim 1.45$) and extremely high coiling rate ($WER \sim 2.55$) at a conch diameter of 100 mm. Whorl profile inverted trapezoidal with gently convergent flanks; venter tectiform with broad longitudinal midventral groove, flanks flattened, umbilical margin broadly rounded. Sculpture with about 6 coarse blunt conical nodes on the umbilical margin per volution; venter without nodes. Suture line with shallow external lobe, very shallow ventrolateral lobe and broadly rounded lateral lobe.

Etymology

From the Latin ‘*inerme*’ (adjective, n.)= ‘unarmed’; because of the lack of nodes on the venter.

Type material

Holotype

IRAN – East Azerbaijan • Zal; *Araxoceras* Beds of the Julfa Formation (early Wuchiapingian); 2013; Korn *et al.* leg.; illustrated in Fig. 37; MB.C.32063.

Description

Specimen MB.C.32063 is a partly corroded, but otherwise fairly well-preserved, fully chambered specimen with a conch diameter of 101 mm; the total diameter including the body chamber has been about 150 mm. It allows the study of one volution (Fig. 37A). It is thinly pachyconic and subevolute ($ww/dm=0.62$; $uw/dm=0.30$) with a weakly depressed whorl profile ($ww/wh=1.44$) and an extremely high coiling rate ($WER=2.53$). The whorl profile is widest at the broadly rounded umbilical margin, from where the steep umbilical wall approaches the umbilical seam. The flanks converge strongly towards the broadly rounded but distinct ventrolateral shoulder. The shape of the venter in the whorl profile is tectiform with a 16 mm wide midventral groove (Fig. 37B). The sculpture consists of six prominent, isolated conical umbilical nodes in the last volution; these become weaker in the course of the last volution. No nodes are visible on the venter. The suture line has a prominent but rounded external lobe and a wide and shallow lateral lobe showing a weak subdivision by a low saddle (with the position at the ventrolateral shoulder; Fig. 37C).

Remarks

Corotainoceras inerme gen. et sp. nov. has a conch shape similar to that of some species of *Tainoceras* and the new genus D to be described by Korn & Hairapetian (in press); this means that the whorl profile is inverted trapezoidal with rapidly converging flanks, a wide venter and a very steep umbilical wall. However, species such as *T. duttoni*, *E. dorsoplicatum* and *E. lutense* have rows of tubercles on the ventral side. The latter lacks the umbilical nodes, which are developed as longitudinal tubercles in *T. duttoni*.

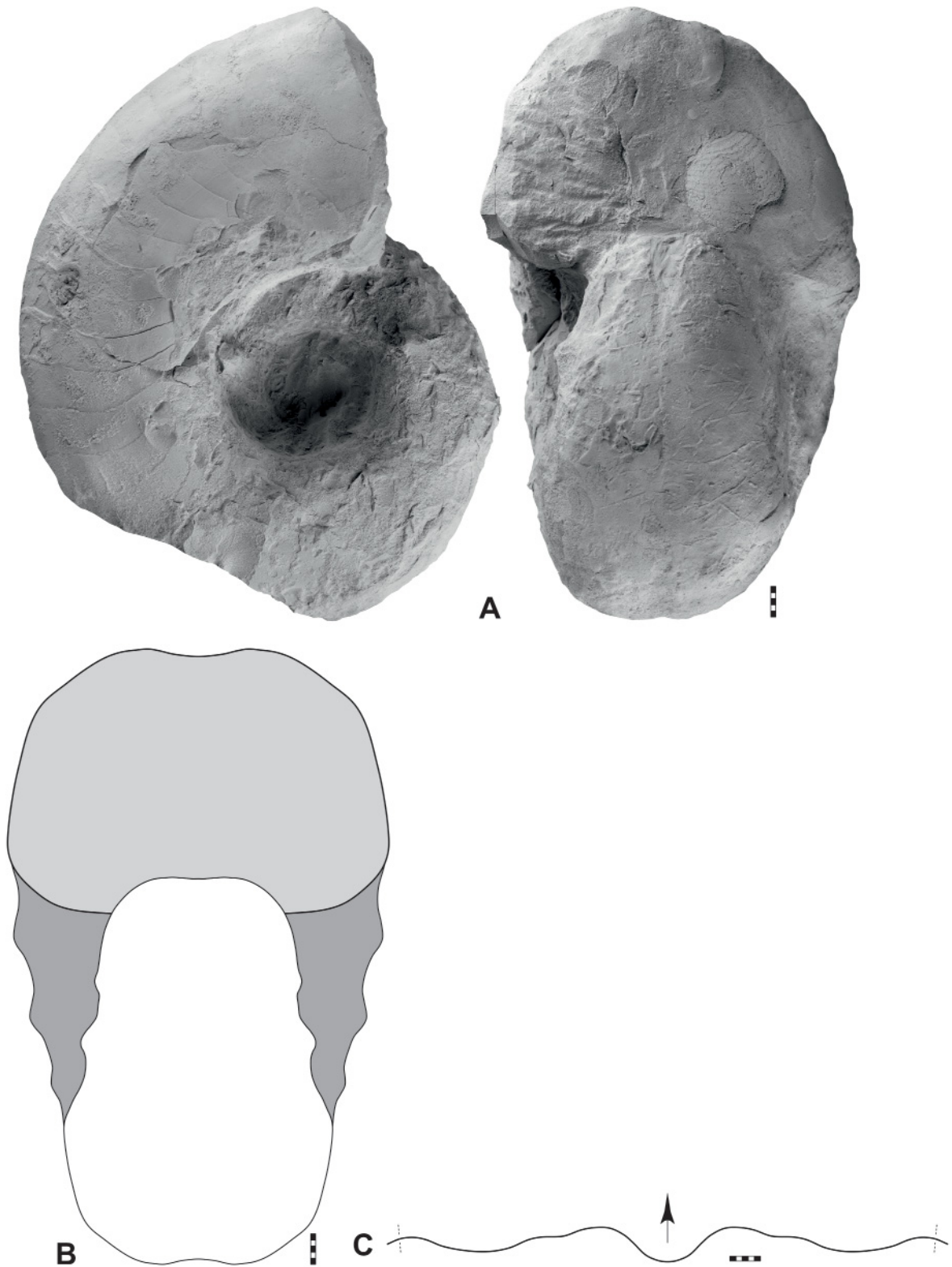

Fig. 37. *Corotainoceras inerme* gen. et sp. nov., holotype MB.C.32063 (Korn *et al.* 2013 Coll.) from the *Araxoceras* Beds of the Julfa Formation at Zal. **A.** Lateral and apertural views. **B.** Reconstruction of apertural view. **C.** Suture line at $ww=56.0$ mm, $wh=36.0$ mm. Scale bar units=1 mm.

Table 22. Conch dimensions (in mm) and ratios of *Corotainoceras inerme* gen. et sp. nov.

| Nr. | dm | ww | wh | uw | ah | ww/dm | ww/wh | uw/dm | WER | IZR |
|------------|-------|------|------|------|------|-------|-------|-------|------|------|
| MB.C.32063 | 100.7 | 62.4 | 43.3 | 30.7 | 37.4 | 0.62 | 1.44 | 0.30 | 2.53 | 0.14 |
| MB.C.32063 | 63.3 | 44.0 | 27.4 | 20.7 | – | 0.70 | 1.61 | 0.33 | – | – |

Genus *Tainionutilus* Mojsisovics, 1902

Type species

Nautilus transitorius Waagen, 1879; subsequent designation by Diener (1915).

Diagnosis

Genus of the family Tainoceratidae with subinvolute or subevolute conch; whorl profile usually subquadrate with shallow midventral longitudinal groove. Umbilical margin usually pronounced and subangular in the intermediate stage, but rounded in the adult stage. Sculpture with blunt ribs on flanks and outer part of the venter; ribs sometimes forming nodes. Suture line with shallow external lobe and broadly rounded lateral lobe. Siphuncle small with subcentral position ventrad of septum centre.

Included Permian species

Pakistan (Waagen 1879; Reed 1931): *Nautilus transitorius* Waagen, 1879, Changhsingian, Salt Range; *Nautilus Wynnei* Waagen, 1879, Changhsingian, Salt Range; *Tainoceras Noelingi* var. *subglobosa* Reed, 1931, Wuchiapingian, Salt Range;

Dolomites (Mojsisovics 1869; Caneva 1906): *Nautilus fugax* Mojsisovics, 1869, Changhsingian; *Pleuromutilus Darini* Caneva, 1906, Changhsingian;

NW Iran (this paper): *Tainionutilus deinceps* sp. nov., Changhsingian.

Remarks

Tainionutilus differs from *Tainoceras* mainly in the absence of the ventral row of nodes. In *Tainionutilus*, the ventrolateral nodes have been modified into radial, curved ribs directed posteriorly on the venter.

Tainionutilus may be one of the genera of Palaeozoic nautiloids that survived the mass extinction at the Permian–Triassic boundary. In addition to the few species from the Late Permian, the species *T. trachyceras* (Frech, 1905) from Early Triassic strata of the Salt Range was mentioned by Frech (1905). Brühwiler *et al.* (2012) mentioned this species from the *Fleminigites nanus* Beds of the Smithian stage.

***Tainionutilus deinceps* sp. nov.**

urn:lsid:zoobank.org:act:C3803C00-1BBD-42EF-B58A-FDD573CCE5C5

Fig. 38; Table 23

Tainionutilus sp. – Shimansky 1965b: 158, pl. 15 fig. 8.

? *Tainionutilus* sp. indet. – Teichert & Kummel 1973: 419, pl. 3 figs 9–10.

Diagnosis

Species of *Tainionutilus* with thinly pachyconic, subinvolute conch and nearly quadrate whorl profile at a conch diameter of about 50 mm. Whorl profile with nearly parallel flanks; venter flattened with a

Table 23. Conch dimensions (partly estimated; in mm) and ratios of *Tainionautilus deinceps* sp. nov.

| Nr. | dm | ww | wh | uw | ah | ww/dm | ww/wh | uw/dm | WER | IZR |
|--------------|------|------|------|-----|----|-------|-------|-------|-----|-----|
| MB.C.32064 | – | 26.5 | 21.0 | – | – | – | 1.26 | – | – | – |
| PIN 1572/424 | 34.0 | 20.4 | 15.6 | 8.2 | – | 0.60 | 1.31 | 0.24 | – | – |
| MCZ 9760 | – | 41.0 | 30.0 | – | – | – | 1.37 | – | – | – |

very shallow longitudinal midventral groove, flanks slightly convex and weakly convergent, umbilical margin and ventrolateral shoulder broadly rounded. Sculpture with five rounded ribs per quarter revolution, extending in forward direction from the umbilical margin and turn back on the flank. Occasionally, ribs are intercalated on the midflank. Venter almost smooth.

Etymology

From the Latin ‘*deinceps*’ (adj.)=‘forward’; because of the course of the ribs on the inner flank.

Type material

Holotype

IRAN – **East Azerbaijan** • Ali Bashi N; *Paratirolites* Limestone (3.15 m below top) of the Ali Bashi Formation (late Changhsingian); 2012; Korn *et al.* leg.; illustrated in Fig. 38; MB.C.32064.

Description

Holotype MB.C.32064 is a segment of slightly over a quarter whorl, with a whorl height of 21 mm (Fig. 38A). Its whorl profile is weakly depressed and almost quadrate. The flanks are nearly parallel, while the umbilical margin and ventrolateral shoulder are rounded. The venter is flattened and has a shallow median groove (Fig. 38B). The sculpture is composed of low, fold-like ribs that are coarsest on the inner half of the flank. The ribs originate from the outer area of the umbilical wall and extend forward. As they reach the middle of the flank, they bend backwards and gradually weaken. They are hardly visible on the venter. Secondary ribs may occasionally appear between the primary ribs on the middle of the flank.

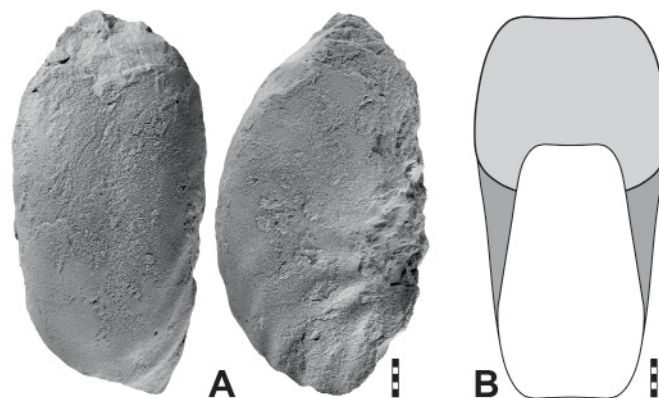

Fig. 38. *Tainionautilus deinceps* sp. nov., holotype MB.C.32064 (Korn *et al.* 2012 Coll.) from the *Paratirolites* Limestone (3.15 m below top) of the Ali Bashi Formation at Ali Bashi N. **A.** Ventral and lateral views. **B.** Reconstruction of apertural view. Scale bar units= 1 mm.

Remarks

Shimansky (1965b: 158) illustrated a specimen that likely belongs to this species, but kept it in open nomenclature. He listed four specimens, which came from the *Paratirolites* Limestone.

It is less clear whether the specimen of “*Tainionutilus* sp. indet.” (MCZ 9760) described by Teichert & Kummel (1973: 419) also belongs to *T. deinceps* sp. nov. With a whorl height of 30 mm, it has a more depressed whorl profile (ww/wh ~ 1.35) than the holotype of *T. deinceps* (ww/wh ~ 1.25). However, this difference could be due to ontogenetic changes; the holotype has a whorl height of only 21 mm. The specimen illustrated by Shimansky (1965b: pl. 15 fig. 8) lies in between (ww/wh ~ 1.30) with a whorl height of 25 mm.

Tainionutilus deinceps sp. nov. can be easily distinguished from the other species of the genus by the very prominent, anteriorly directed ribs on the inner half of the flank. In *T. deinceps* the ribs are weakly developed in the ventrolateral region, whereas in the other species they are most strongly developed there.

Genus *Tirolonutilus* Mojsisovics, 1902

Type species

Nautilus crux Stache, 1877, subsequent designation by Kummel (1953).

Diagnosis

Genus of the family Tainoceratidae with subinvolute or subevolute conch; whorl profile trapezoidal with concave venter and subangular ventrolateral shoulder. Flanks convergent or nearly parallel, umbilical margin broadly rounded. Sculpture with one row of longitudinally elongated ribs on the ventrolateral shoulder; flanks smooth or with weak ribs. Suture line with moderately deep, rounded external lobe and broadly rounded lateral lobe. Siphuncle small with subcentral position ventrad of septum centre.

Included Permian species

Southern Europe and Alps (Stache 1877; Merla 1930; Schr ter 1974): *Nautilus crux* Stache, 1877, Changhsingian, Dolomites; *Nautilus sebedinus* Stache, 1877, Changhsingian, Dolomites; *Nautilus Hoernesii* Stache, 1877, Changhsingian, Dolomites [synonym of *Tirolonutilus sebedinus* (Stache, 1877)]; *Metacoceras discoideum* Merla, 1930, Changhsingian, Dolomites [synonym of *Tirolonutilus crux* (Stache, 1877)]; *Tirolonutilus bicristatus* Merla, 1930, Changhsingian, Dolomites [synonym of *Tirolonutilus sebedinus* (Stache, 1877)]; *Tirolonutilus lativentralis* Schr ter, 1974, Changhsingian, B kk Mountains; *Tirolonutilus cruciformis* Schr ter, 1974, Changhsingian, B kk Mountains.

Saudi Arabia (Chirat *et al.* 2006): *Tirolonutilus feltgeni* Chirat *et al.* 2006, Changhsingian.

Remarks

Tirolonutilus can be identified by the distinctly trapezoidal whorl profile with the sulcate venter, the longitudinal ribs on the ventrolateral shoulder and the absence of sculpture on umbilical margin. The genus has a similar morphology to *Tainionutilus*, but the whorl profile is usually more compressed and the venter is more deeply concave.

Tirolonutilus is a genus that has only been found in a few regions. Several species have been described from the *Bellerophon* Limestone of the Dolomites, including those by Stache (1877), Merla (1930), Posenato & Prinoth (2004) and Prinoth & Posenato (2007). Additionally, reports of *Tirolonutilus* have come from Saudi Arabia (Chirat *et al.* 2006) and Azerbaijan (Kotlyar *et al.* 1983).

Tirolonautilus sp. 1

Fig. 39

Material examined

IRAN – **West Azerbaijan** • 1 specimen; Aras Valley; Zal Member of the Ali Bashi Formation (early Changhsingian); 2011; Korn *et al.* leg.; illustrated in Fig. 39; MB.C.32065.

Description

Specimen MB.C.32065 is a distorted individual with a diameter of 62 mm (Fig. 39). Despite being laterally crushed and deformed, it still exhibits recognisable conch, sculpture, and suture characters. Its shape is thinly discoidal and subinvolute, with clearly parallel flanks. The ventrolateral shoulder is pronounced, and the venter is concave with a rather deep longitudinal groove. On each side, between this groove and the ventrolateral shoulder, there are two rows of nodes elongated in the growth direction. These nodes create a tuberculate outline of the whorl spiral. On the last volution, there are 15 of these nodes.

Remarks

The specimen is too poorly preserved for a more detailed discussion. It appears that the umbilicus is narrower than in *Tirolonautilus* sp. 2.



Fig. 39. *Tirolonautilus* sp. 1, specimen MB.C.32065 (Korn *et al.* 2011 Coll.) Zal Member of the Ali Bashi Formation at Aras Valley, lateral and ventral views. Scale bar units= 1 mm.

Tirolonautilus sp. 2

Fig. 40

Material examined

IRAN – **East Azerbaijan** • 1 specimen; Ali Bashi 4; *Paratirolites* Limestone (2.80 m below top) of the Ali Bashi Formation (late Changhsingian); 2011; Korn *et al.* leg.; illustrated in Fig. 40B; MB.C. 32066.

Description

Specimen MB.C.32066 is a badly corroded and thus poorly preserved individual with a diameter of 93 mm (Fig. 40B). It can, however, because of its characteristic longitudinal nodes on the venter on both sides of the deep median groove (Fig. 40), be attributed to the genus *Tirolonautilus*. These nodes extend, at least at the beginning of the last whorl, as low ribs towards the midflank, where they wedge out.

Remarks

The conch form and sculpture of the specimen from Julfa bears some resemblance to *T. sebedinus* from the Dolomites (Prinow & Posenato 2007). However, the ribs on the flank are noticeably sharper in *T. sebedinus* and extend towards the umbilical margin. Unfortunately, the poor preservation of the specimen from Ali Bashi precludes a more detailed discussion.

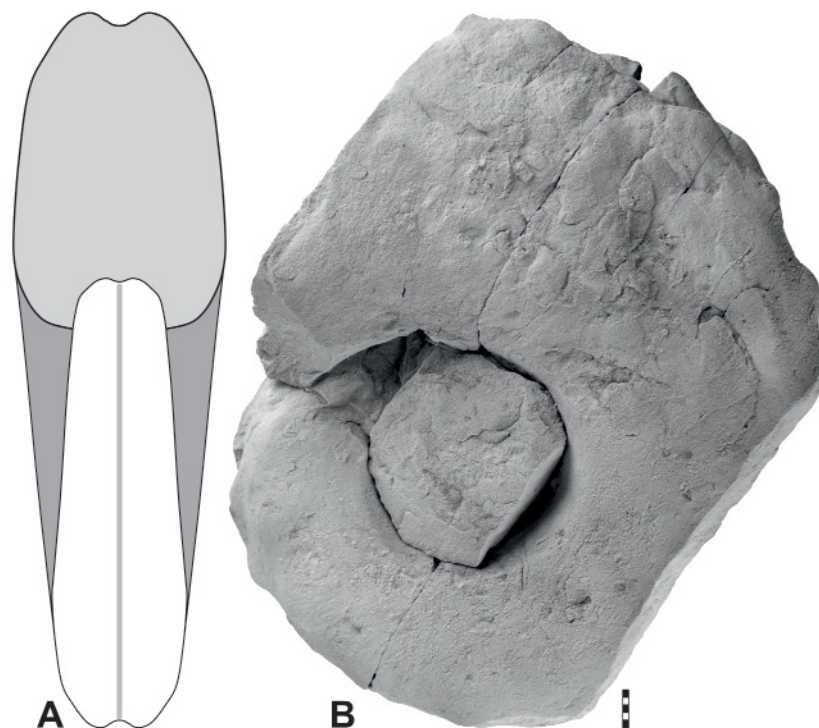

Fig. 40. *Tirolonautilus* sp. 2, specimen MB.C.32066 (Korn *et al.* 2011 Coll.) from the *Paratirolites* Limestone (2.80 m below top) of the Ali Bashi Formation at Ali Bashi 4. **A.** Lateral view. **B.** Reconstruction of apertural view. Scale bar units = 1 mm.

Suborder **Liroceratina** Flower, 1955

Diagnosis

Suborder of the order Nautilida, in which an umbilical margin is formed early in ontogeny; advanced species may regress this character. Conch usually pachyconic and rarely discoidal or globular, subinvolute to involute. Juvenile whorl profile circular. Adult whorl profile usually circular or depressed oval without distinct ventrolateral shoulder in the early species, showing modifications during evolution (inverted trapezoidal with convergent flanks and flattened venter). Dorsal whorl zone always present, small to

moderately deep. Juvenile sculpture with spiral lines that may be restricted to the umbilical area in the early species; adult sculpture usually lacking except for spiral lines in some species. Septa simply domed in the early species; with dorsal inflexion in advanced species and with corrugated septa in two derived clades. Suture line depending on the whorl profile, usually with shallow lobes and low saddles; with distinct lobes in two clades (from Korn 2025).

Included superfamilies

Liroceratoidea Hyatt, 1900 (Carboniferous to Triassic); Ehippioceratoidea Miller & Youngquist, 1949 (Carboniferous to Permian); Clydonautoidea Hyatt, 1900 (Triassic to Jurassic).

Remarks

A discussion of the suborder Liroceratina has been given by Korn (2025).

Superfamily Liroceratoidea Hyatt, 1900

Diagnosis

Superfamily of the suborder Liroceratina with a pachyconic and rarely discoidal or globular, subinvolute to involute conch. Whorl profile usually circular or depressed oval without distinct ventrolateral shoulder; in some species with a pronounced but rounded ventrolateral shoulder. Dorsal whorl zone usually small to moderately deep. Juvenile sculpture in the early species with spiral lines that may be restricted to the umbilical area; derived species are often smooth. Suture line very simple, almost straight across flanks and venter (from Korn 2025).

Included families

Liroceratidae Miller & Youngquist, 1949 (Carboniferous to Triassic); Coloceratidae Hyatt, 1893 [homonym; synonym of Liroceratidae Miller & Youngquist, 1949]; Paranautilidae Kummel in Flower & Kummel, 1950 (Triassic); Permonautilidae Barskov & Shilovsky, 2014 (Permian); Planetoceratidae Korn, 2025 (Carboniferous); Julfanautilidae fam. nov. (Permian).

Remarks

A detailed discussion of the Liroceratoidea has been given by Korn (2025).

Family Liroceratidae Miller & Youngquist, 1949

Diagnosis

Family of the superfamily Liroceratoidea with a usually pachyconic or globular, subinvolute to subevolute conch. Whorl profile in the adult stage usually more or less strongly depressed; flanks and venter form a continuous arch in the early species, the venter can be flattened or concave in advanced species. Umbilical margin rounded; umbilical wall usually convex. Ornament usually consisting of fine growth lines; spiral lines occur in some genera. Septum simple in shape, concavely domed; suture line very simple, almost straight across flanks and venter or with small lobes and saddles (from Korn 2025).

Included genera

Solenoceras Hyatt, 1884 [homonym of *Solenoceras* Conrad, 1860; objective synonym of *Coelogasteroceras*]; *Coelogasteroceras* Hyatt, 1893 (Carboniferous to Permian); *Coloceras* Hyatt, 1893 [homonym of *Coloceras* Taschenberg, 1882; synonym of *Liroceras* Teichert, 1940]; *Stearoceras* Hyatt, 1893 (Carboniferous to Permian); *Peripetoceras* Hyatt, 1894 (Carboniferous to Permian); *Potoceras*

Hyatt, 1894 (Carboniferous); *Nannoceras* Hyatt, 1894 [nomen nullum; synonym of *Peripetoceras*]; *Conradiceras* Cossmann, 1900 [objective synonym of *Coelogasteroceras*]; *Liroceras* Teichert, 1940 (Carboniferous to Permian); *Condraoceras* Miller, Lane & Unklesbay, 1947 (Carboniferous to Permian); *Periptoceras* Chao, 1954 [nomen nullum; synonym of *Peripetoceras*]; *Hemiliroceras* Ruzhencev & Shimansky, 1954 (Carboniferous to Permian); *Bistrialites* Turner, 1954 (Carboniferous); *Pseudophacoceras* Turner, 1966 (Carboniferous); *Neobistrialites* Tucker, Mapes & Aronoff, 1978 (Carboniferous); *Jianoceras* Ma, 1997 (Permian); *Nemdocer* Barskov & Shilovsky, 2014 (Permian); *Paraliroceras* Barskov & Shilovsky, 2014 (Permian); *Tatianautilus* Barskov & Shilovsky, 2014 (Permian); *Leniceras* Leonova & Shchedukhin, 2020 (Permian); *Shikhanonautilus* Leonova & Shchedukhin, 2020 (Permian); *Thyoceras* Leonova & Shchedukhin, 2020 (Permian); *Celeroliroceras* gen. nov. (Permian); *Perunautilus* Crick & Sobolev, 1994 (Triassic); *Tomponautilus* Sobolev, 1989 (Triassic).

Remarks

A detailed discussion of the Liroceratidae has been given by Korn (2025).

Genus *Liroceras* Teichert, 1940

Type species

Coloceras liratum Girty, 1911; original designation.

Diagnosis

Genus of the family Liroceratidae with pachyconic to globular, involute or subinvolute conch; umbilicus closed by a plug in some species. The first whorl is 10–20 mm in diameter with a very small umbilical foramen; the conch is rapidly increasing in height with a high coiling rate (WER usually higher than 2.50). Whorls weakly embracing, their profile ranges from reniform to nearly circular. Juvenile conch with longitudinal ridges or lines; adult ornament with growth lines with a fairly deep ventral sinus and spiral lines in some species. Septa without inflexions, slightly concave. Suture line simple, nearly straight with a shallow, broadly rounded internal lobe. The siphuncle has a position between the centre of the septum and the venter (after Gordon 1965; Shimansky 1967).

Included Carboniferous species

North America (Shumard & Swallow 1858; Miller & Gurley 1897; Girty 1911; Miller *et al.* 1933; Newell 1936; Unklesbay 1962; Gordon 1965): *Nautilus Missouriensis* Swallow, 1858, Bashkirian, Missouri; *Solenochilus henryvillense* Miller & Gurley, 1897, Viséan, Indiana; *Coloceras liratum* Girty, 1911, Moscovian, Oklahoma; *Coloceras liratum* var. *obsoletum* Girty, 1911, Moscovian, Oklahoma; *Coloceras greenei* Miller, Dunbar & Condra, 1933, Kasimovian, Oklahoma; *Coloceras milleri* Newell, 1936, Kasimovian, Kansas; *Coloceras reticulatum* Miller & Owen, 1937, Kasimovian, Oklahoma; *Liroceras patulum* Unklesbay, 1962, Bashkirian, Arkansas; *Liroceras bicostatum* Gordon, 1965, Serpukhovian, Arkansas.

British Isles (Foord 1891; Hind 1910; Turner 1954; Ramsbottom & Moore 1961): *Coelonautilus Derbiensis* Foord, 1891, Viséan, Derbyshire; *Coelonautilus Derbiensis* var. *globulare* Foord, 1891, Viséan, Isle of Man; *Solenocheilus globosus* Hind, 1910, Bashkirian, Lancashire; *Liroceras lunense* Turner, 1954, Serpukhovian, Yorkshire; *Liroceras leitrimense* Ramsbottom & Moore, 1961, Viséan, Ireland.

Central Europe (Trenkner 1868; Hyatt 1894; Miller *et al.* 1933; Schmidt 1951): *Nautilus grundensis* Trenkner, 1868, Viséan, Harz Mountains; *Coloceras globatum* Hyatt, 1894, Viséan, Belgium; *Coloceras*

hyatti Miller, Dunbar & Condra, 1933, Viséan, Belgium; *Liroceras occlusor* Schmidt, 1951, Viséan, Harz Mountains; *Liroceras schaelkense* Schmidt, 1951, Viséan, Rhenish Mountains.

North Africa (Korn & Klug 2023): *Liroceras karaouii* Korn & Klug, 2023, Viséan, Anti-Atlas; *Liroceras vermis* Korn & Klug, 2023, Serpukhovian, Anti-Atlas.

Western Russia (Eichwald 1857; Shimansky 1967): *Nautilus excentricus* Eichwald, 1857, Serpukhovian, Western Russia; *Liroceras fornicatum* Shimansky, 1967, Serpukhovian, Western Russia; *Liroceras devjatovense* Shimansky, 1967, Moscovian, Moscow Basin.

Urals (Shimansky 1967): *Liroceras praelunense* Shimansky, 1967, Viséan, North Urals; *Liroceras ruzhencevi* Shimansky, 1967, Serpukhovian, South Urals.

North China (Ruan & Zhou 1987): *Liroceras reniforme* Ruan & Zhou, 1987, Bashkirian, Ningxia.

Included Permian species

North America (Hyatt 1893): *Coloceras globulare* Hyatt, 1893, Artinskian, Texas.

Central and Southern Europe (Gemmellaro 1889; Prinoth & Posenato 2007): *Endolobus salomonensis* Gemmellaro, 1889, Wordian, Sicily; *Liroceras gardenense* Prinoth & Posenato, 2007, Changhsingian, Dolomites.

Western Russia, Urals (Yakovlev 1899; Kruglov 1928; Barskov *et al.* 2014; Leonova & Shchedukhin 2020): *Asymptoceras korulkense* Yakovlev, 1899, Sakmarian, South Urals; *Coloceras* (?) *sarvaensis* Kruglov, 1928, Sakmarian (?), South Urals; *Coloceras abichi* var. *tastubense* Kruglov, 1928, Sakmarian (?), South Urals; *Liroceras volgense* Barskov & Shilovsky, 2014, Roadian, Western Russia; *Liroceras shakhtauense* Leonova & Shchedukhin, 2020, Asselian or Sakmarian, South Urals.

NW Iran (this paper): *Liroceras choopani* sp. nov., Wuchiapingian.

Central Iran (Korn & Hairapetian in press): new species P to be described by Korn & Hairapetian (in press), Wuchiapingian.

Pakistan (Reed 1944): *Liroceras bakhense* Reed, 1944, Wuchiapingian, Salt Range.

South China (Chao 1940, 1954; Xu 1977; Zhao *et al.* 1978; Liang 1984; Wu & Kuang 1992): *Coloceras sinense* Chao, 1940, Kungurian, Hunan; *Peripetoceras hsueyuechiani* Chao, 1954, Kungurian, Hunan; *Liroceras orientale* Chao, 1954, Kungurian, Hunan; *Ephippioceras hunanense* Chao, 1954, Kungurian, Hunan; *Liroceras didmyoaurise* Xu, 1977, Kungurian, Hunan; *Liroceras meishanense* Zhao, Liang & Zheng, 1978, Changhsingian, Zhejiang; *Liroceras chenxianense* Liang, 1984, Changhsingian, Hunan; *Liroceras lichuanense* Wu & Kuang, 1992, Changhsingian, Hubei.

Indopacific (Haniel 1915): *Nautilus Molengraaffi* Haniel, 1915, Wuchiapingian, Timor.

Madagascar (Vaillant-Couturier Treat 1933): *Nautilus waterloti* Vaillant-Couturier Treat, 1933, Wuchiapingian.

Remarks

The genus *Liroceras* was introduced by Teichert (1940) for those Carboniferous and Permian nautiloids that were previously mostly included in the genus *Coloceras* Hyatt, 1893. The name *Coloceras* had already been used by Taschenberg (1882) as a subgenus for recent Mallophaga.

Liroceras has a stratigraphic range from the Viséan to the Changhsingian and is represented by species at almost all stages of this long interval. At the same time, *Liroceras* is geographically widespread, both in the Carboniferous and in the Permian. *Liroceras* is also known from different facies areas; Early Carboniferous species are known from shallower and deeper areas of the shelf. In the Late Permian, the genus was more common in the shallower areas of the sea, as suggested by the occurrences at Julfa, where it co-occurs with the morphologically similar and closely related genus *Permonautilus*.

***Liroceras choopani* sp. nov.**

urn:lsid:zoobank.org:act:47A75088-13DD-4168-B8B0-07AEAA7A93E5

Figs 41–42; Table 24

Liroceras sp. indet. – Teichert *et al.* 1973: 401, pl. 8 fig. 9.

Liroceras sp. – Gliwa *et al.* 2020: text-fig. 17e.

Diagnosis

Species of *Liroceras* with thinly globular, involute conch (ww/dm ~0.85–0.90; uw/dm ~0.05), moderately depressed whorl profile (ww/wh ~1.50–1.65) and high to very high coiling rate (WER ~2.00–2.35) between a conch diameter of 75 and 135 mm. Whorl profile with broadly arched venter and flanks, broadly rounded umbilical margin and convex umbilical wall and deep imprint zone (IZR ~0.40). Ornament with coarse, convex growth lines and coarse spiral lines. Suture line nearly straight.

Etymology

Named after Hadi Choopan, former Iranian Mr Olympia, referring to the most robust nautiloid found in the Julfa assemblage.

Type material

Holotype

IRAN – **East Azerbaijan** • Zal; *Araxoceras* Beds of the Julfa Formation (early Wuchiapingian); 2018; Ghaderi leg.; illustrated in Fig. 41A; MB.C.32067.

Paratypes

IRAN – **East Azerbaijan** • 1 specimen; same data as for holotype; illustrated in Fig. 41B–C; MB.C.32068 • 1 specimen; Ali Bashi 4; *Araxoceras* Beds of the Julfa Formation (early Wuchiapingian); 2018; Ghaderi leg.; MB.C.32069 • 1 specimen; same data as for holotype; 2010; Korn *et al.* leg.; MB.C.32070 • 1 specimen; Ali Bashi; *Araxoceras* Beds of the Julfa Formation (early Wuchiapingian); illustrated in Fig. 42; GLM#GH1005. – **West Azerbaijan** • 1 specimen; Aras Valley; *Araxoceras* Beds of the Julfa Formation (early Wuchiapingian); 2013; Korn *et al.* leg.; illustrated in Fig. 41D–E; MB.C.29350.

Description

Holotype MB.C.32067 is an incomplete specimen with a conch diameter of approximately 133 mm (Fig. 41A). The proportions of the conch can only be estimated; the specimen was apparently globular

Fig. 41 (opposite page). *Liroceras choopani* sp. nov. from the *Araxoceras* Beds of the Julfa Formation. **A.** Holotype MB.C.32067 (Ghaderi 2018 Coll.) from Zal, lateral and apertural views with dorsal view reconstruction. **B.** Paratype MB.C.32068 (Ghaderi 2018 Coll.) from Zal, cross section. **C.** The same specimen, suture line at ww=84.5 mm. **D.** Paratype MB.C.29350 (Korn *et al.* 2013 Coll.) from Aras Valley, lateral and ventral views. **E.** The same specimen; reconstruction of apertural view. Scale bar units=1 mm.

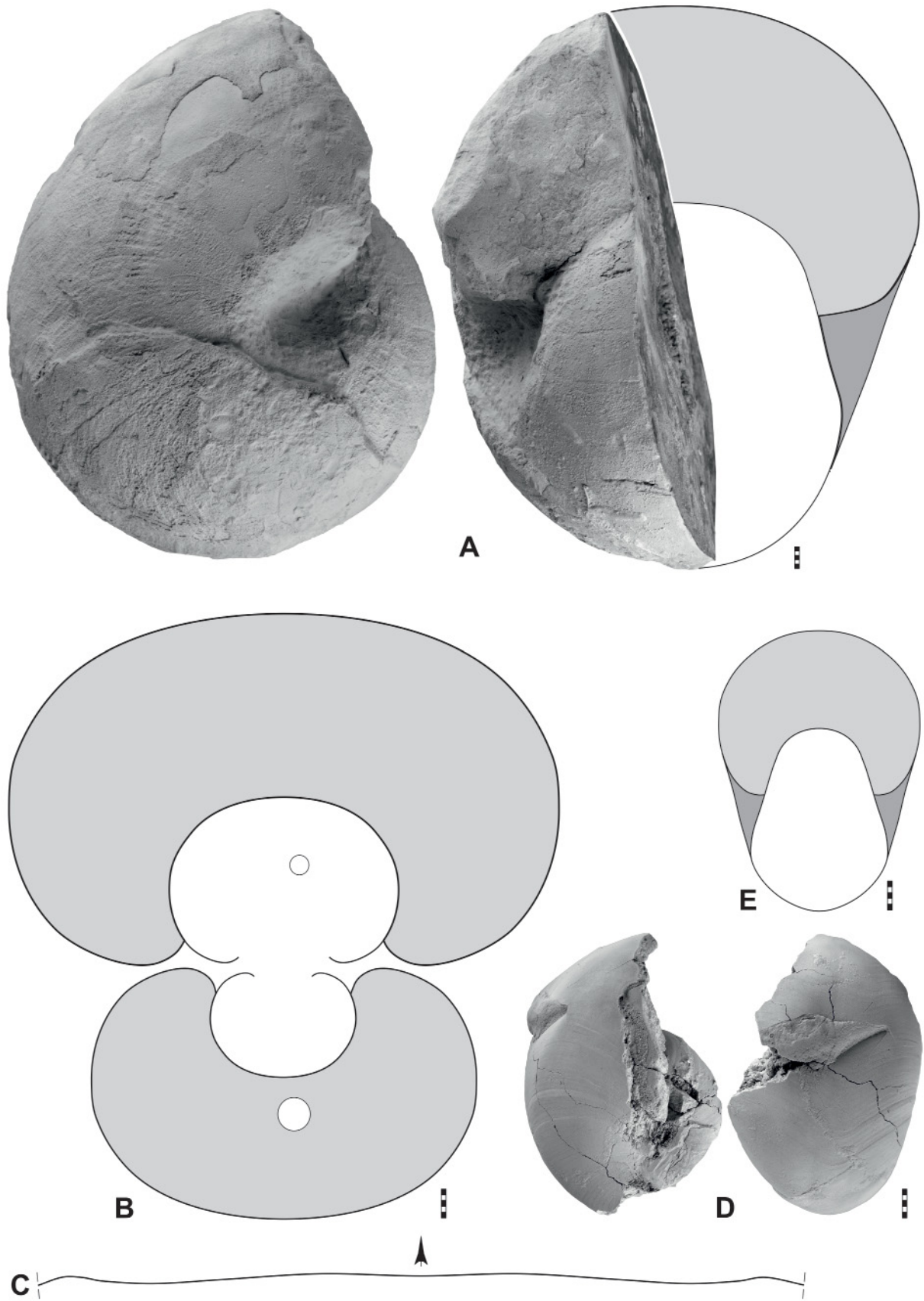

($w/dm \sim 0.90$) with an almost closed umbilicus and a moderately high coiling rate ($WER \sim 2.10$). The whorl profile is semilunate and widest at the broadly rounded umbilical margin; it has a deep imprint zone ($IZR \sim 0.40$). Flanks and venter are continuously rounded to form a hemisphere. Shell remains show very coarse growth lines, which extend with a convex arch across the flanks and form a deep, subangular ventral sinus. A second element of ornament are coarse spiral lines, which are almost of the same strength as the growth lines, together forming a reticulated ornament.

Paratype MB.C.32068 with a conch diameter of 112 mm was sectioned for studying the conch ontogeny (Fig. 41B), but the inner whorls are recrystallised or deformed. However, it shows an almost isometric ontogeny between 48 and 113 mm diameter. During this interval of one and a half volutions, the conch changes from thickly pachyconic ($w/dm = 0.82$ at 48.5 mm dm) to thinly globular ($w/dm = 0.87$ at 113 mm dm). The umbilicus is almost closed (uw/dm decreases from 0.06 to 0.02). The suture line of the specimen is almost straight with a very shallow external lobe and an also very shallow lateral lobe (Fig. 41C).

The smaller fragmentary paratype MB.C.29350 with a conch diameter of 50 mm had to be reconstructed for its conch proportions (Fig. 41E), but it is evident that it is slightly slenderer than the two large specimens ($w/dm \sim 0.78$). This specimen is preserved with shell material that shows rhythmically reinforced growth lines extending with a broadly rounded lateral projection and a deep subangular ventral sinus.

Remarks

Liroceras choopani sp. nov. is one of the few species in the species-rich genus with an almost closed umbilicus and is therefore easy to distinguish from many other species, which usually have a uw/dm ratio of about 0.20. Among the Middle and Late Permian species with a nearly closed umbilicus,

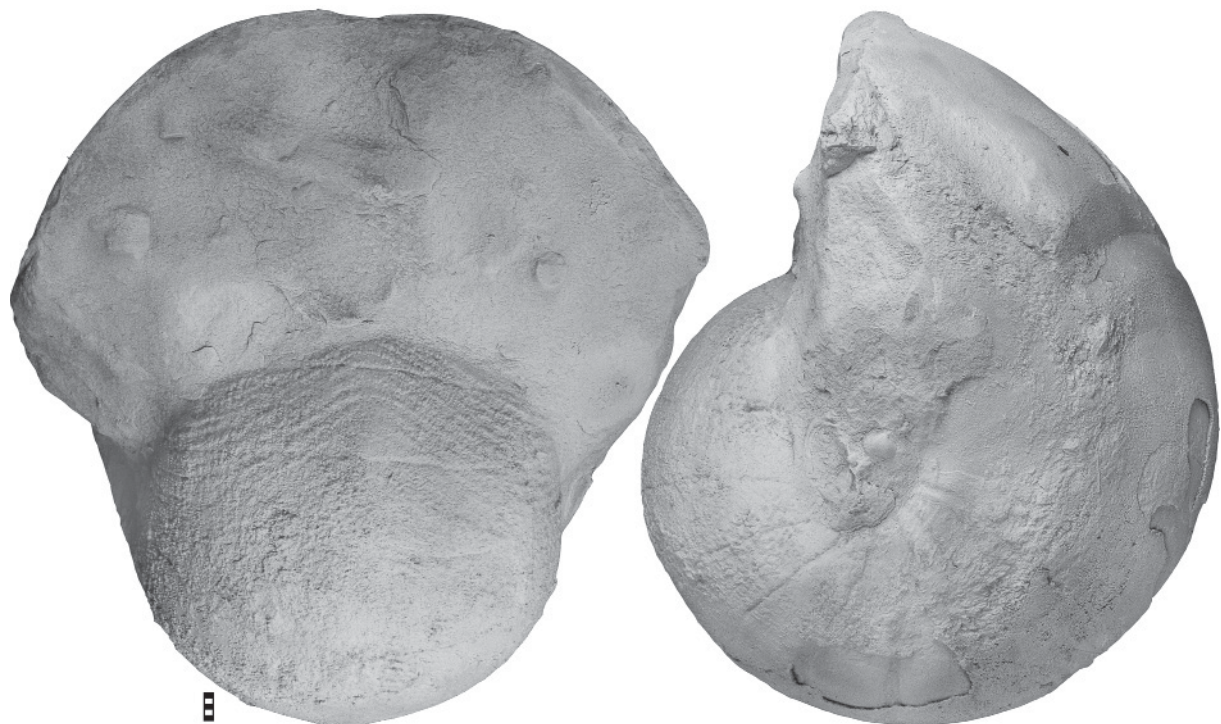

Fig. 42. *Liroceras choopani* sp. nov., paratype GLM#GH1005 from the *Araxoceras* Beds of the Julfa Formation from Julfa, dorsal and lateral views. Scale bar units = 1 mm.

Table 24. Conch dimensions (in mm) and ratios of *Liroceras choopani* sp. nov.; reconstructed dimensions and ratios in italics.

| Nr. | dm | ww | wh | uw | ah | ww/dm | ww/wh | uw/dm | WER | IZR |
|------------|-------|--------------|------|-----|------|-------------|-------------|-------|------|------|
| MB.C.32067 | 133.0 | <i>118.0</i> | 71.0 | 7.0 | 41.0 | <i>0.89</i> | <i>1.66</i> | 0.05 | 2.09 | 0.42 |
| MB.C.32068 | 113.0 | 98.2 | 66.5 | 2.5 | 38.8 | 0.87 | 1.48 | 0.02 | 2.32 | 0.42 |
| MB.C.32068 | 74.2 | 66.4 | 44.0 | 3.3 | 25.7 | 0.89 | 1.51 | 0.04 | 2.34 | 0.42 |
| MB.C.32068 | 48.5 | 39.7 | 26.9 | 2.9 | – | 0.82 | 1.48 | 0.06 | – | – |
| MB.C.29350 | 49.5 | 38.5 | 28.0 | 1.0 | 17.0 | <i>0.78</i> | <i>1.38</i> | 0.02 | 2.32 | 0.39 |

L. meishanense and *L. hsuechuechiani* (Chao, 1854) are slender ($ww/dm \sim 0.57$ and 0.67 , respectively), *L. gardenense* and *L. didmyourise* are stouter ($ww/dm > 0.90$) at comparable conch diameters.

Large specimens of *L. choopani* sp. nov. have a coarser ornamentation consisting of growth lines and spiral lines. Such an adult ornament is not known from other species, although only a few species with a conch diameter of over 100 mm are known.

Genus *Celeroliroceras* gen. nov.

urn:lsid:zoobank.org:act:DDB55D63-9584-47C5-B8B4-BD69879FDB4F

New genus G – Korn 2025: 66.

Type species

Celeroliroceras celere gen. et sp. nov.

Diagnosis

Genus of the family Liroceratidae with globular, involute or subinvolute conch. The conch is rapidly increasing in height with an extraordinarily high coiling rate (WER higher than 3.50). Whorls very weakly embracing with nearly circular profile. Adult ornament very weak. Septa without inflexions, slightly concave. Suture line simple, nearly straight to straight with shallow lobes.

Etymology

Combination of the Latin ‘*celere*’ (adjective, n.)= ‘fast’ and *Liroceras*; because of the conch geometry with the extraordinarily high coiling rate.

Included species

NW Iran (this paper): *Celeroliroceras celere* gen. et sp. nov., Wuchiapingian.

Remarks

Celeroliroceras gen. nov. is a genus that differs from *Liroceras* in its extraordinarily high coiling rate of the conch. The type species has a whorl expansion rate of over 3.60, a value far above that of most species of *Liroceras*. The whorl expansion rate of liroceratids is usually around 2.50. The new species is therefore placed in its own genus.

The conch of *Celeroliroceras* gen. nov. is very reminiscent of that of the genus *Solenochilus* Meek & Worthen, 1870, which is also characterised by an exceptionally high whorl expansion rate. However, the position of the siphuncle, central in *Celeroliroceras* and marginally ventral in *Solenochilus*, indicates that both genera belong to phylogenetically distant evolutionary lineages.

Celeroliroceras celere gen. et sp. nov.

urn:lsid:zoobank.org:act:B1A2F8FC-0603-4F60-A7BA-5E5735C44FF2

Fig. 43; Table 25

Liroceras sp. – Gliwa *et al.* 2020: text-fig. 17g.

Diagnosis

Species of *Celeroliroceras* gen. nov. with thinly globular, subinvolute to involute conch (ww/dm ~0.85–0.90; uw/dm ~0.15), weakly to moderately depressed whorl profile (ww/wh ~1.40–1.60) and extraordinarily high coiling rate (WER ~3.60) between a conch diameter of 30 and 60 mm. Whorl profile with broadly arched venter and flanks, broadly rounded umbilical margin and convex umbilical wall and small imprint zone (IZR ~0.15). Shell surface smooths. Suture line nearly straight.

Etymology

From the Latin ‘*celere*’ (adjective, n.)=‘fast’; because of the conch geometry with the extraordinarily high coiling rate.

Type material

Holotype

IRAN – **West Azerbaijan** • Aras Valley; *Araxoceras* Beds of the Julfa Formation (early Wuchiapingian); 2011; Korn *et al.* leg.; illustrated in Fig. 43; MB.C.29352.

Description

Holotype MB.C.29352 is fully septate with a conch diameter of 57 mm (Fig. 43A). It is slightly deformed but relatively well preserved, allowing the study of conch geometry, suture line and, with limitations, ornamentation. The remarkable conch geometry is mainly caused by the extraordinarily high coiling rate (WER=3.60). The conch is globular and involute (ww/dm=0.88; uw/dm=0.14) and the ww/wh ration amounts 1.60. The whorl profile is crescent-shaped with a convex umbilical wall and a rounded umbilical margin from which the flanks converge strongly towards the broadly rounded venter (Fig. 43B). The

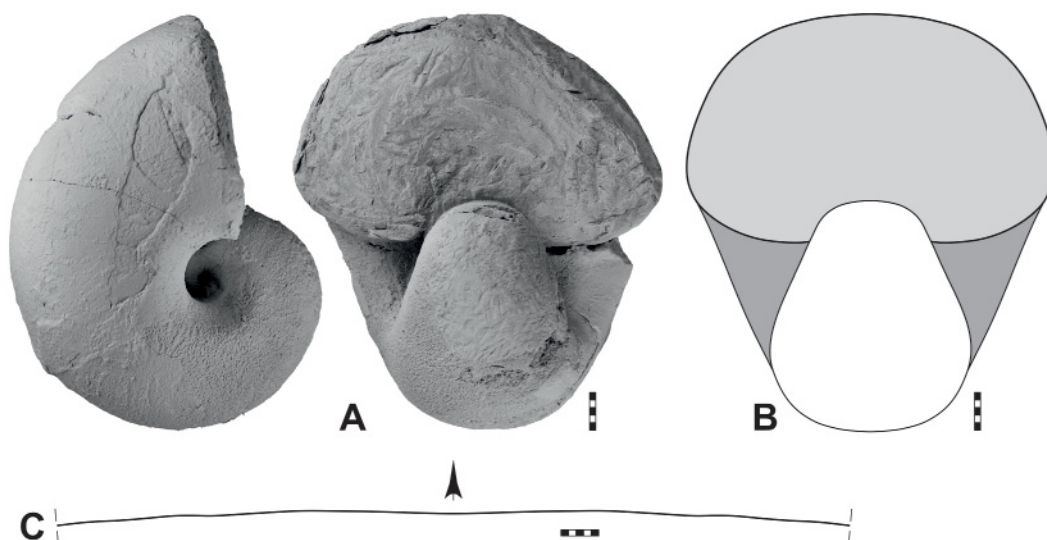

Fig. 43. *Celeroliroceras celere* gen. et sp. nov., holotype MB.C.29352 (Korn *et al.* 2011 Coll.) from the *Araxoceras* Beds of the Julfa Formation at Aras Valley. **A.** Lateral and apertural views. **B.** Reconstruction of apertural view. **C.** Suture line at dm=57.0 mm, ww=46.5 mm, wh=27.2 mm. Scale bar units=1 mm.

Table 25. Conch dimensions (in mm) and ratios of *Celeroliroceras celere* gen. et sp. nov.

| Nr. | dm | ww | wh | uw | ah | ww/dm | ww/wh | uw/dm | WER | IZR |
|------------|------|------|------|-----|------|-------|-------|-------|------|------|
| MB.C.29352 | 57.1 | 50.5 | 31.6 | 7.8 | 27.0 | 0.88 | 1.60 | 0.14 | 3.60 | 0.15 |
| MB.C.29352 | 32.6 | 28.5 | 19.9 | 5.7 | – | 0.87 | 1.43 | 0.17 | – | – |

whorl overlap zone is very small (IZR=0.15). It appears that the whorl width increases faster than the whorl height on the last volution; the ww/wh ratio increases from 1.43 to 1.60 during the last half volution.

There are some shell remains attached to the phragmocone; these are almost smooth with no traces of ornamentation. The suture line is almost straight, but has a very flat and very wide external lobe (Fig. 43C).

Remarks

Celeroliroceras celere gen. et sp. nov. is very different from all other Late Permian nautiloids. It is clearly separable from the co-occurring *Liroceras choopani* sp. nov. by its extraordinarily high coiling rate (WER=3.60 in contrast to 2.30 in *L. choopani*) and the much smaller whorl overlap rate.

Celeroliroceras sp.

Fig. 44; Table 26

Material examined

IRAN – **West Azerbaijan** • 1 specimen; Aras Valley; *Vedioceras* Beds of the Julfa Formation (late Wuchiapingian); 2011; Korn *et al.* leg.; illustrated in Fig. 44; MB.C.32071.

Description

Specimen MB.C.32071 is a fragment of a juvenile specimen with a conch diameter of 35 mm (Fig. 44A). It shows a thickly pachyconic, involute conch (ww/dm=0.82; uw/dm=0.12) with a weakly depressed oval whorl profile (ww/wh=1.43). The coiling rate is extraordinarily high (WER=3.35).

Remarks

The specimen is too poorly preserved for a more detailed description. Because of the conch geometry and the extraordinarily high coiling rate, it probably belongs to *Celeroliroceras* gen. nov.

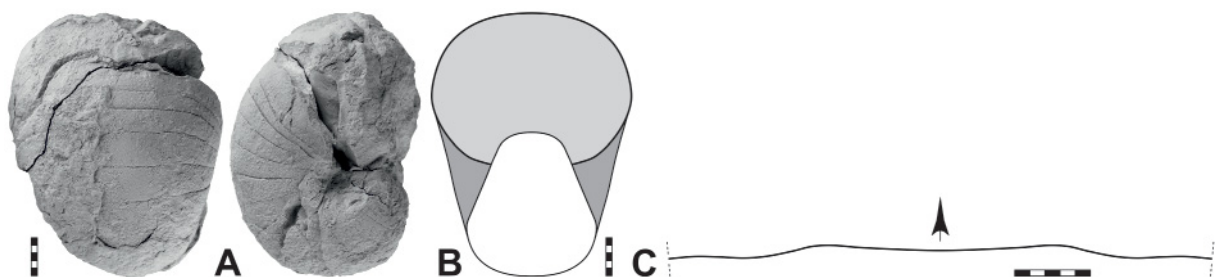

Fig. 44. *Celeroliroceras* sp., specimen MB.C.32071 (Korn *et al.* 2011 Coll.) from the *Vedioceras* Beds of the Julfa Formation at Aras Valley. **A.** Ventral and lateral views. **B.** Reconstruction of apertural view. **C.** Suture line at dm=24.5 mm, ww=22.0 mm, wh=13.2 mm. Scale bar units=1 mm.

Table 26. Conch dimensions (in mm) and ratios of *Celeroliroceras* sp.

| Nr. | dm | ww | wh | uw | ah | ww/dm | ww/wh | uw/dm | WER | IZR |
|------------|------|------|------|-----|------|-------|-------|-------|------|------|
| MB.C.32071 | 34.6 | 28.4 | 19.9 | 4.1 | 15.7 | 0.82 | 1.43 | 0.12 | 3.35 | 0.21 |

Genus *Peripetoceras* Hyatt, 1894

Type species

Nautilus Freieslebeni Geinitz, 1843; original designation.

Diagnosis

Genus of the family Liroceratidae with pachyconic or rarely globular, involute or subinvolute conch. The conch is rapidly increasing in height with a very high to extremely high coiling rate (WER usually 2.40–3.00). Whorls weakly embracing with nearly circular profile in the juvenile stage and with a flattened venter in the adult stage. Adult ornament very weak. Septa without inflexions, slightly concave. Suture line nearly straight to straight with shallow lobes.

Included Carboniferous species

North America (Gordon 1960, 1965; Tucker & Mapes 1978; Tucker *et al.* 1978; Niko & Mapes 2015, 2017): *Peripetoceras whitei* Gordon, 1960, Bashkirian, Indiana; *Peripetoceras ozarkense* Gordon, 1965, Serpukhovian, Arkansas; *Peripetoceras bridgeportense* Tucker & Mapes, 1978, Kasimovian, Texas; *Peripetoceras wewokense* Tucker, Mapes & Aronoff, 1978, Moscovian, Oklahoma; *Peripetoceras milleri* Niko & Mapes, 2015, Serpukhovian, Arkansas; *Peripetoceras kummeli* Niko & Mapes, 2017, Serpukhovian, Arkansas.

British Isles (Hind 1910; Bisat 1930): *Cyclonautilus umbilicatus* Hind, 1910, Bashkirian, Lancashire; *Peripetoceras dubium* Bisat, 1930, Bashkirian, Wales.

South Urals (Shimansky 1967): *Peripetoceras cautum* Shimansky, 1967, Serpukhovian.

Western Russia (Shimansky 1967): *Peripetoceras globatoides* Shimansky, 1967, Serpukhovian; *Peripetoceras tormentum* Shimansky, 1967, Serpukhovian; *Peripetoceras fischeri* Shimansky, 1967, Moscovian.

Included Permian species

Central Europe (Geinitz 1841; King 1850; Prinoth & Posenato 2007): *Nautilus Freieslebeni* Geinitz, 1843, Wuchiapingian, Saxony; *Nautilus bowerbankianus* King, 1850, Wuchiapingian, England [synonym of *Peripetoceras freieslebeni* (Geinitz, 1843)]; *Peripetoceras comploji* Prinoth & Posenato, 2007, Changhsingian, Dolomites; *Peripetoceras gigas* Prinoth & Posenato, 2007, Changhsingian, Dolomites.

West Russia and Urals (Ruzhencev & Shimansky 1954; Barskov *et al.* 2014): *Peripetoceras asselense* Ruzhencev & Shimansky, 1954, Artinskian, South Urals; *Peripetoceras ideliense* Barskov & Shilovsky in Barskov *et al.*, 2014, Roadian, West Russia; *Peripetoceras burovi* Barskov & Shilovsky in Barskov *et al.*, 2014, Roadian, West Russia.

NW Iran (this paper): *Peripetoceras parum* sp. nov., Wuchiapingian.

Indopacific (Haniel 1915): *Nautilus Wanneri* Haniel, 1915, Kungurian, Timor; *Endolobus (Solenocheilus) Brouweri* Haniel, 1915, Kungurian, Timor.

Remarks

According to Shimansky (1967), *Peripetoceras* differs from *Liroceras* in having a less involute conch, a shallow ventral lobe and a slightly dorsally displaced siphuncle. However, these characters do not always allow a reliable separation; the box-shaped or inverted trapezoidal whorl profile in the adult stage can also be used as a further distinguishing criterion. It is not certain whether the Permian species also have a displaced siphuncle. *Coelogasteroceras* is similar to *Peripetoceras*, but differs mainly in the concave venter.

Gordon (1965) and Shimansky (1967) considered *Peripetoceras* to be a very long-lived genus with a range from the late Early Carboniferous to the Late Permian. In fact, the Serpukhovian, Bashkirian and Moscovian species included in this genus are very similar to the Permian species, so it is a very conservative evolutionary line with little morphological change. In this respect, *Peripetoceras* would be comparable to *Liroceras*.

Peripetoceras parum sp. nov.

urn:lsid:zoobank.org:act:4E83F0AE-DC82-4664-A104-362C6A5809DD

Fig. 45; Table 27

Diagnosis

Species of *Peripetoceras* with thickly pachyconic, subinvolute conch ($ww/dm \sim 0.75$; $uw/dm \sim 0.15$), weakly depressed whorl profile ($ww/wh \sim 1.45$) and extremely high coiling rate ($WER \sim 2.65$) at a conch diameter of 70 mm. Whorl profile rounded rectangular with flatly arched venter and flanks, broadly rounded ventrolateral shoulder and umbilical margin, convex umbilical wall and a moderately deep imprint zone ($IZR \sim 0.25$). Suture line with extremely shallow external and lateral lobe.

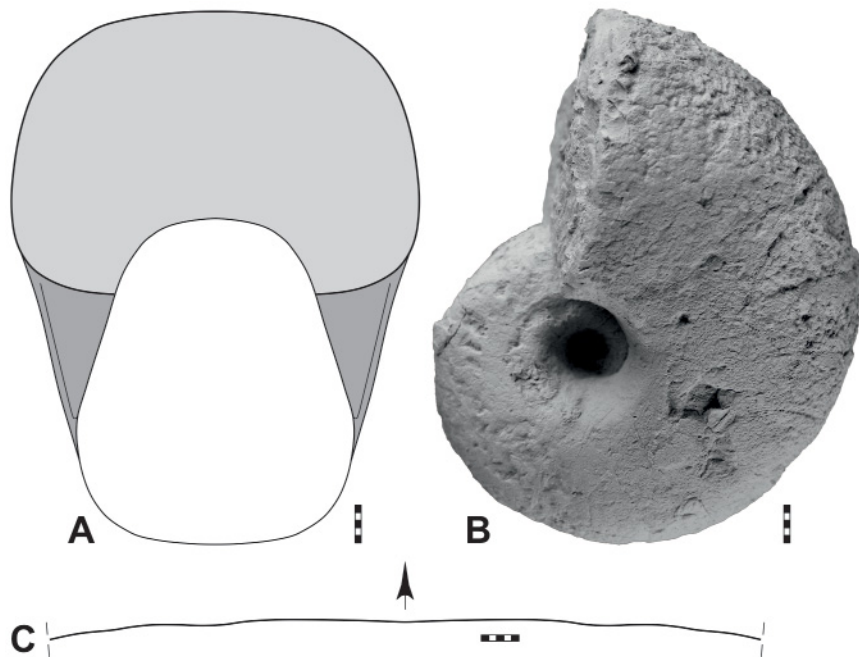

Fig. 45. *Peripetoceras parum* sp. nov., holotype MB.C.32072 (Korn *et al.* 2011 Coll.) from the *Vedioceras* Beds of the Julfa Formation at Aras Valley. **A.** Reconstruction of apertural view. **B.** Lateral view. **C.** Suture line at $dm=70.0$ mm, $ww=39.3$ mm, $wh=26.8$ mm. Scale bar units=1 mm.

Table 27. Conch dimensions (in mm) and ratios of *Peripetoceras parum* sp. nov.

| Nr. | dm | ww | wh | uw | ah | ww/dm | ww/wh | uw/dm | WER | IZR |
|------------|------|------|------|------|------|-------|-------|-------|------|------|
| MB.C.32072 | 70.4 | 53.9 | 37.4 | 11.2 | 27.3 | 0.77 | 1.44 | 0.16 | 2.67 | 0.27 |
| MB.C.32072 | 43.1 | 36.7 | 22.2 | 6.9 | – | 0.85 | 1.65 | 0.16 | – | – |

Etymology

From the Latin ‘*parum*’ (adjective, n.)= ‘even’; because of the nearly straight suture line.

Type material

Holotype

IRAN – **West Azerbaijan** • Aras Valley; *Vedioceras* Beds of the Julfa Formation (late Wuchiapingian); 2011; Korn *et al.* leg.; illustrated in Fig. 45; MB.C.32072.

Paratype

IRAN – **West Azerbaijan** • 1 specimen; same data as for holotype; 2018; Ghaderi leg.; MB.C.32073.

Description

Holotype MB.C.32072 is a fairly complete but corroded specimen with a conch diameter of 70 mm (Fig. 45B). It is thickly pachyconic and subinvolute ($ww/dm=0.77$; $uw/dm=0.16$). The conch is expanding rapidly and has a very high coiling rate ($WER=2.67$). On the last volution there are some changes in the shape of the whorl profile observable: while the cross section at the beginning of the last whorl is rather circular, at the end it is depressed ($ww/wh=1.44$) with a flattened venter and slightly flattened flanks. The ventrolateral shoulder is rounded, as is the umbilical margin; the umbilical wall is steep and slightly flattened (Fig. 45A). The suture line extends with shallow undulation and possesses very shallow external and lateral lobes (Fig. 45C).

Remarks

Peripetoceras parum sp. nov. differs from the other Late Permian species of the genus in its general conch shape. *Peripetoceras comploji* and *P. gigas* are stouter and narrower umbilicate ($ww/dm \sim 0.85$; $uw/dm \sim 0.10$) than *P. parum* ($ww/dm \sim 0.75$; $uw/dm \sim 0.15$). However, it should be noted that the first two species were described from very large specimens, approximately twice the size of the holotype of *P. parum*. *Peripetoceras freieslebeni* has a slenderer conch ($ww/dm \sim 0.65$) than *P. parum*.

The two Roadian species *P. ideliense* and *P. burovi* have a significantly larger umbilicus ($uw/dm \sim 0.30$) than *P. parum* sp. nov. Of the Kungurian species *P. wanneri* and *P. brouweri*, the former is slenderer ($ww/dm \sim 0.70$) and the latter is stouter ($ww/dm \sim 0.85$). *Peripetoceras parum* sp. nov. also differs from *P. wanneri* in having a much more rounded ventrolateral shoulder and less clearly flattened flanks and venter.

Family **Permonautilidae** Barskov & Shilovsky, 2014

Diagnosis

Family of the superfamily Liroceratoidea with a pachyconic or globular, usually subinvolute to subevolute conch. Whorl profile in the adult stage usually more or less strongly depressed; flanks and venter form a continuous arch in the early forms, the venter can be flattened or concave in advanced forms. Terminal aperture with long lateral shell processes emerging from the umbilical margin. Ornament consisting of fine or coarse growth lines. Septum simple in shape, concavely domed; suture line very simple, almost straight across flanks and venter or with small lobes and saddles (from Korn 2025).

Included genera

Permonautilus Kruglov, 1933 (Permian); *Alexandronautilus* Shimansky, 1962 (Permian) [synonym of *Permonautilus* Kruglov, 1933].

Remarks

A detailed discussion of the family Permonautilidae has been given by Korn (2025).

Genus *Permonautilus* Kruglov, 1933

Type species

Nautilus cornutus Golovkinsky, 1868; original designation.

Diagnosis

Family of the family Permonautilidae with pachyconic or globular, usually subinvolute to subevolute conch. Whorl profile in the adult stage usually more or less strongly depressed; flanks and venter form a continuous arch in the early forms, the venter can be flattened or concave in advanced forms. Terminal aperture with long lateral shell processes emerging from the umbilical margin. Ornament consisting of fine or coarse growth lines. Septum simple in shape, concavely domed; suture line very simple, almost straight across flanks and venter or with small lobes and saddles.

Included species

Greenland (Tichy 1975): *Permonautilus halleri* Tichy, 1975, Wuchiapingian.

Western Russia (Golovkinsky 1868; Kruglov 1933; Barskov *et al.* 2014): *Nautilus cornutus* Golovkinsky, 1868, Roadian; *Permonautilus pinegaensis* Kruglov, 1933, Roadian; *Permonautilus parapinegaensis* Barskov & Shilovsky, 2014, Roadian; *Permonautilus kruglovi* Barskov & Shilovsky, 2014, Roadian.

Transcaucasia (Kruglov 1933): *Coloceras Abichi* Kruglov, 1928, Wuchiapingian, Azerbaijan.

Central Iran (Korn & Hairapetian in press): new species Q to be described by Korn & Hairapetian (in press), Wuchiapingian.

Remarks

The species of *Permonautilus* have a very similar morphology; differences lie in the whorl width/whorl height ratio, the width of the umbilicus and the shape of the whorl profile. The genus is currently only known from the two Permian stages Roadian and Wuchiapingian; no representatives have yet been reported from the Wordian and Capitanian stages in between.

***Permonautilus abichi* (Kruglov, 1928)**

Figs 46–48; Table 28

Coloceras Abichi Kruglov, 1928: 89.

Permonautilus Abichi – Kruglov 1933: 187.

Permonautilus (Alexandronautilus) abichi – Shimansky 1962: 162, pl. 4 figs 4–5.

Permonautilus abichi – Shimansky 1965a: 41. — Gliwa *et al.* 2020: text-fig. 17f.

Nautilus excentricus – Abich 1878: 16, pl. 1 fig. 4.

Nautilus concavus – Abich 1878: 18, pl. 3 figs 3–4.

Nautilus cornutus – von Arthaber 1900: 211, pl. 18 fig. 1.

Liroceras sp. indet. – Teichert & Kummel 1973: 424, pl. 3 figs 11–12.

? *Nautilus propinquus* Abich, 1878: 16, pl. 3 fig. 6.

Diagnosis

Species of *Permonautilus* with thickly pachyconic to thinly globular, subinvolute conch (ww/dm=0.75–0.90; uw/dm ~0.20), moderately depressed whorl profile (ww/wh=1.70–2.00) and very high coiling rate (WER=2.25–2.35) at a conch diameter of 40–80 mm. Whorl profile with broadly arched venter and flanks, broadly rounded umbilical margin, convex umbilical wall and moderately wide imprint zone (IZR ~0.20). Without sculpture. Suture line nearly straight.

Material examined

IRAN – **East Azerbaijan** • 1 specimen; Ali Bashi N; *Araxoceras* Beds of the Julfa Formation (early Wuchiapingian); 2018; Korn *et al.* leg.; illustrated in Fig. 46; MB.C.32074 • 1 specimen; Ali Bashi 4; *Araxoceras* Beds of the Julfa Formation (early Wuchiapingian); 2018; Ghaderi leg.; illustrated in Fig. 47A–C; MB.C.32075 • 1 specimen; same data as for preceding; 2011; Korn *et al.* leg.; illustrated in Fig. 47D; MB.C.32076 • 1 specimen; Ali Bashi 4; *Araxoceras* Beds of the Julfa Formation (early Wuchiapingian); 2018; Ghaderi leg.; MB.C.32085 • 5 specimens; same data as for preceding; 2010; Korn *et al.* leg.; MB.C.32086 to MB.C.32090 • 1 specimen; same data as for preceding; 2002; Weyer leg.; MB.C.32091 • 1 specimen; Ali Bashi N; *Araxoceras* Beds of the Julfa Formation (early Wuchiapingian); 2018; Korn *et al.* leg.; MB.C.32092 • 2 specimens; Zal; *Araxoceras* Beds of the Julfa Formation (early Wuchiapingian); 2013; Korn *et al.* leg.; MB.C.32093, MB.C.32094 • 2 specimens; Ali Bashi; *Araxoceras* Beds of the Julfa Formation (early Wuchiapingian); illustrated in Fig. 48A–B; GLM#GH1003, GLM#GH1001. – **West Azerbaijan** • 1 specimen; Aras Valley; *Araxoceras* Beds of the Julfa Formation (early Wuchiapingian); 2018; Ghaderi leg.; illustrated in Fig. 47E–F; MB.C.32077 • 1 specimen; same data as for preceding; illustrated in Fig. 47G–H; MB.C.29351 • 5 specimens; same data as for preceding; MB.C.32078 to MB.C.32082 • 1 specimen; Aras Valley; *Araxoceras* Beds of the Julfa Formation (early Wuchiapingian); 2011; Korn *et al.* leg.; MB.C.32083 • 1 specimen; same data as for preceding; 2018; Korn *et al.* leg.; MB.C.32084.

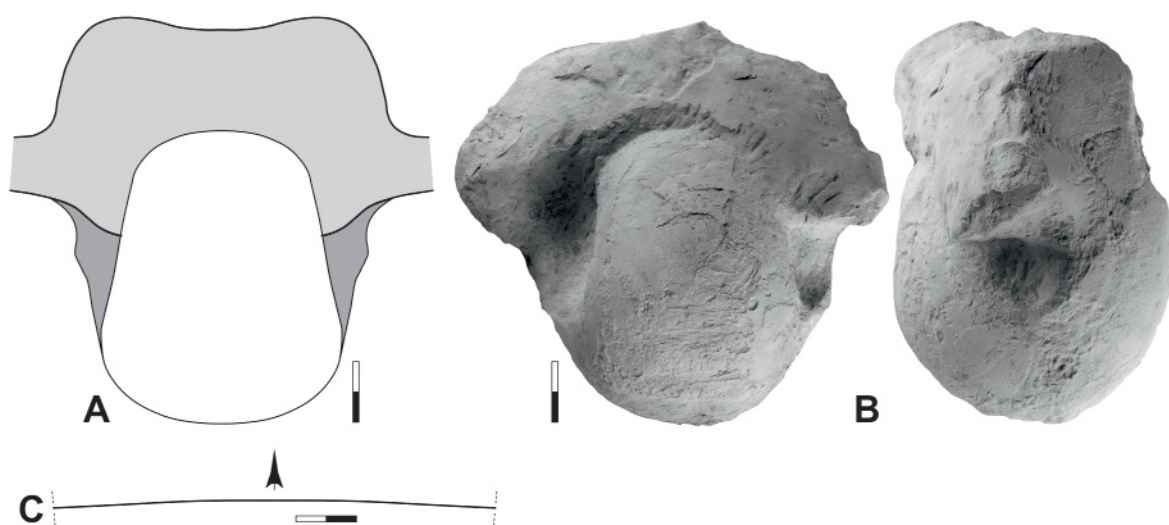

Fig. 46. *Permonautilus abichi* (Kruglov, 1928), specimen MB.C.32074 (Korn *et al.* 2018 Coll.) from the *Araxoceras* Beds of the Julfa Formation at Ali Bashi. **A.** Reconstruction of apertural view. **B.** Dorsal and lateral views. **C.** Suture line at ww=74.0 mm, wh=43.0 mm. Scale bar units=10 mm.

Description

Specimen MB.C.32074 is probably a fully mature individual. It has a conch diameter of 134 mm and possesses the main criterion for adulthood, which are the umbilical shell processes (Fig. 46B). Although the specimen is slightly crushed ventrally, it is possible to obtain the main measurements of the conch. The conch is pachyconic in the terminal stage and the umbilicus is rather narrow ($ww/dm=0.74$;

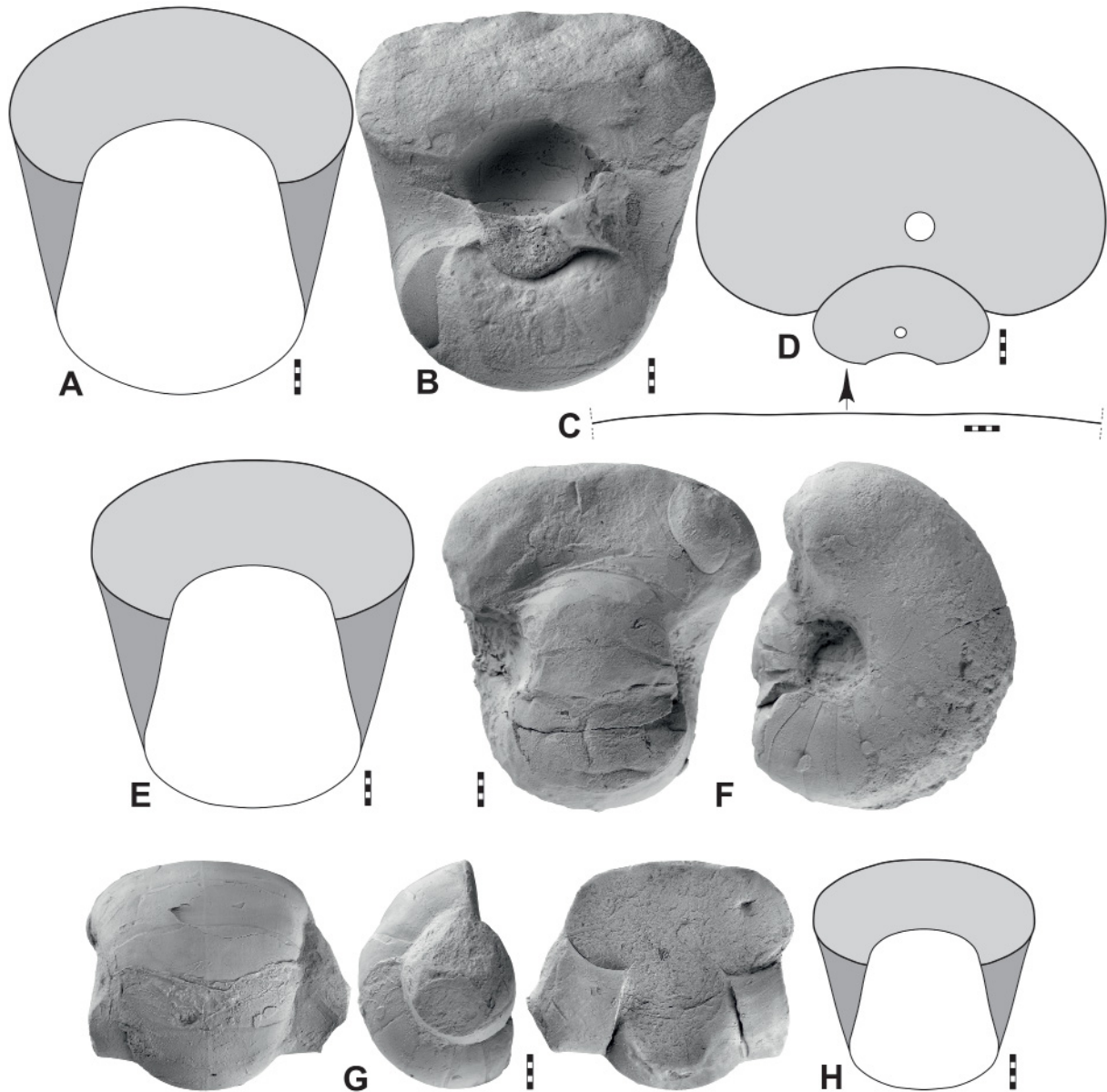

Fig. 47. *Permonautilus abichi* (Kruglov, 1928) from the *Araxoceras* Beds of the Julfa Formation. **A.** Specimen MB.C.32075 (Ghaderi 2018 Coll.) from Ali Bashi 4, reconstruction of apertural view. **B.** The same specimen, apertural view. **C.** The same specimen, suture line at $ww=38.2$ mm, $wh=22.5$ mm. **D.** Specimen MB.C.32076 (Korn *et al.* 2011 Coll.) from Ali Bashi, whorl profiles. **E.** Specimen MB.C.32077 (Ghaderi 2018 Coll.) from Aras Valley, reconstruction of apertural view. **F.** The same specimen, dorsal and lateral views. **G.** Specimen MB.C.29351 (Ghaderi 2018 Coll.) from Aras Valley, ventral, lateral and apertural views. **H.** The same specimen, reconstruction of apertural view. Scale bar units = 1 mm.

Table 28. Conch dimensions (in mm) and ratios of *Permonautilus abichi* (Kruglov, 1928).

| Nr. | dm | ww | wh | uw | ah | ww/dm | ww/wh | uw/dm | WER | IZR |
|------------|-------|------|------|------|------|-------|-------|-------|------|------|
| MB.C.32074 | 134.0 | 99.0 | 64.5 | 19.0 | 39.5 | 0.74 | 1.53 | 0.14 | 2.01 | 0.39 |
| MB.C.32074 | 94.5 | 74.0 | 43.0 | – | – | 0.78 | 1.72 | – | – | – |
| MB.C.32088 | 84.5 | 66.0 | 40.5 | 16.5 | 28.0 | 0.78 | 1.63 | 0.20 | 2.24 | 0.31 |
| MB.C.32076 | 78.0 | 58.7 | 34.3 | 12.0 | 27.0 | 0.75 | 1.71 | 0.15 | 2.34 | 0.21 |
| MB.C.32075 | 56.4 | 49.8 | 25.6 | 10.7 | 18.9 | 0.88 | 1.95 | 0.19 | 2.26 | 0.26 |
| MB.C.32080 | 56.0 | 46.1 | 25.0 | 10.5 | 19.5 | 0.82 | 1.84 | 0.19 | 2.35 | 0.22 |
| MB.C.32077 | 50.5 | 44.5 | 22.0 | 10.8 | 17.0 | 0.88 | 2.02 | 0.21 | 2.27 | 0.23 |
| MB.C.29351 | 33.6 | 32.0 | 16.5 | – | – | 0.95 | 1.94 | – | – | – |
| MB.C.32091 | 28.2 | 31.5 | 12.9 | 6.3 | 10.6 | 1.12 | 2.44 | 0.22 | 2.57 | 0.18 |

uw/dm=0.14). The whorl profile suffered from deformation, but the symmetry of the specimen suggests that the venter was probably concave near the terminal aperture. On both sides of the specimen there are remnants of lateral umbilical processes, hemispherical in section and about 22 mm in diameter. As they are broken it is impossible to determine their original length. The shell remains appear smooth but show traces of fine growth lines, which are almost straight in their course across the flank. The septa are crowded at the end of the phragmocone at a conch diameter of about 94 mm; the suture line has an almost straight course (Fig. 46C).

The smaller specimens show that intraspecific variation in conch geometry is rather limited. Specimen MB.C.32075 may serve as a characteristic example (Fig. 47A–B). It is a fragment with a conch diameter of 56 mm and has a globular and subinvolute shape (ww/dm=0.88; uw/dm=0.19) with a moderately depressed whorl profile (ww/wh=1.95) and a very high coiling rate (WER=2.26). However, the specimen differs from the others in that it is the only individual to show remnants of a coarse ornament, visible only in a small area as impressions on the internal mould. It appears that the specimen has rather coarse growth lines, spaced about one millimetre apart, with a rather shallow and wide sinus extending across the venter. The suture line is almost straight (Fig. 47C).

Specimens MB.C.29351 (34 mm dm; Fig. 47G) and MB.C.32077 (51 mm dm; Fig. 47F) give an impression of the ontogenetic development of the conch, in which no major changes can be seen. The conch is thinly globular (ww/dm=0.95 and 0.88 respectively) and the whorl width is approximately twice the whorl height.



Fig. 48. *Permonautilus abichi* (Kruglov, 1928) from the *Araxoceras* Beds of the Julfa Formation of Ali Bashi. **A.** Specimen GLM#GH1003, lateral and ventral views. **B.** Specimen GLM#GH1001, ventral and dorsal views. Scale bar units= 1 mm.

Specimen MB.C.32076 (78 mm dm; Fig. 47D) has a similar morphology but is slenderer ($w/w/dm=0.75$). In this specimen the septa of two consecutive whorls can be seen. They show a displaced siphuncle with a diameter of 0.15 of the aperture height.

A characteristic visible in nearly all the specimens is the presence of a midventral longitudinal line on the internal mould, being produced by a thin internal groove in the shell. The character was already figured by Abich (1878: pl. 3 fig. 3) and described under the species “*Nautilus concavus*”.

Remarks

Abich (1878) described the following species, which may belong to *Permonutilus abichi*:

- “*Nautilus excentricus* Eichwald”. – The fully chambered specimen with a conch diameter of 30 mm described and illustrated by Abich (1878: pl. 1 fig. 4) has an almost spherical shape with a rather wide umbilicus ($uw/dm=0.40$). Flanks and venter are broadly rounded. The suture line is almost straight but forms a shallow lobe on the venter.
- “*Nautilus propinquus*, nov. form.”. – Abich (1878: pl. 3 fig. 6) described and illustrated only a small, chambered specimen with a conch diameter of about 20 mm. It shows a narrowly umbilicate conch with a clear umbilical margin and apparently broadly rounded flank and venter. The suture line is almost straight. This specimen is probably not suitable to characterise a species.
- “*Nautilus concavus* Sowerby”. – Abich (1878: pl. 3 figs 3–4) illustrated two fragments with about 50 mm and a conch diameter of 40 mm, respectively. The smaller specimen is better preserved and shows the whorl profile of an inner whorl. At a diameter of 16 mm, the conch is globular ($w/w/dm=1.03$) with a very narrow umbilicus ($uw/dm=0.10$) and a depressed whorl profile ($w/w/wh=1.90$). The whorl profile shows a shallow dorsal inflexion.

Already von Arthaber (1900) suggested that it is not clear whether the three species described by Abich (1878), “*Nautilus excentricus*”, “*Nautilus propinquus*” and “*Nautilus concavus*”, belong to one single species. He synonymised these three species with the Middle Permian *Nautilus cornutus* Golovkinsky, 1869 from the Volga Basin of Russia. In a revision of this occurrence, Kruglov (1928) discussed “*Nautilus excentricus*” of Abich and gave it the new name “*Coloceras Abichi*”. Kruglov (1933) later placed this species in his new genus *Permonutilus*. Shimansky (1962c) then used this species to found the new subgenus *Permonutilus (Alexandronutilus)*, which should be distinguished from the nominal genus by the presence of thin transverse ribs. In a later account (Shimansky 1965a), however, he did not use this anymore. Barskov *et al.* (2014), when revising the Middle Permian cephalopods of the Volga-Ural region, also did not use the subgenus. Instead, they separated the genus *Permonutilus* and their new genus *Nemdoceras* from the Liroceratidae, for which they introduced the new family Permonautilidae that is characterised by their spiny umbilical projections.

The presence of umbilical shell processes in the material from Julfa was already suggested by von Arthaber (1900: 212), but the specimen he cited (von Arthaber 1900: pl. 18 fig. 1) is probably too small to have developed such projections. The large specimen MB.C.32074 now allows us to clearly assign the material to *Permonutilus*. Our material differs from the species from the Volga-Ural region mainly by the narrower umbilicus (uw/dm is about 0.15, in contrast to 0.20–0.30 in the species from the Volga).

Teichert & Kummel (1973) did not list *Permonutilus* among their collection from Ali Bashi, although Shimansky (1965a) mentioned 28 specimens in his collection from the neighbouring sites north of the Aras River, meaning that it is a commonly occurring genus. It is most likely that the material attributed to *Liroceras* sp. indet. by Teichert & Kummel (1973) in fact belongs to *Permonutilus*.

Family **Julfanautilidae** fam. nov.

urn:lsid:zoobank.org:act:9B985B5C-9C06-4713-A6C1-763F6D4B4AA4

new family – Korn 2025: 65, 69, fig. 35.

Type genus

Julfanautilus gen. nov.

Diagnosis

Family of the superfamily Liroceratoidea with a usually pachyconic, subinvolute to involute conch. Whorl profile in the adult stage usually more or less strongly depressed; flanks and venter usually separated by distinct ventrolateral shoulder, venter flattened or concave. Umbilical margin subangular or angular; umbilical wall steep, flattened. Ornament usually consisting of fine growth lines. Septum simple in shape, concavely domed; suture line with shallow lobes on venter and flank.

Etymology

Named after the type genus *Julfanautilus* gen. nov.

Included genera

Julfanautilus gen. nov. (Permian); new genus E to be described by Korn & Hairapetian (in press) (Permian); new genus F to be described by Korn & Hairapetian (in press) (Permian).

Remarks

The family Julfanautilidae fam. nov. is characterised by a combination of characters not found in any other family of Palaeozoic nautilids. This is the combination of a rather stout conch with a very pronounced umbilical margin and also a sometimes pronounced ventrolateral shoulder. While the first character suggests a placement in the superfamily Liroceratoidea, the second and third characters show a closer morphological relationship to the superfamilies Pleuronautiloidea and Grypoceratoidea. Unfortunately, the early ontogenetic development of the conch in the species of the Julfanautilidae is not known. However, the material shows that the pronounced umbilical margin is present early in ontogeny and that this feature can therefore be considered apomorphic, whereas the ventrolateral shoulder does not assume a subangular shape until a late ontogenetic stage, if at all. Therefore, these forms are included here as a new family of the superfamily Liroceratoidea.

Genus **Julfanautilus** gen. nov.

urn:lsid:zoobank.org:act:D5ED78D7-D4E4-43D0-B9E9-193D3554B4AB

new genus H – Korn 2025: 69, fig. 35.

Type species

Julfanautilus ashourii gen. et sp. nov.

Diagnosis

Genus of the family Julfanautilidae fam. nov. with thinly pachyconic, involute or subinvolute conch. Conch rapidly increasing in height with an extremely or extraordinarily high coiling rate (WER higher than 2.50). Whorls weakly embracing, whorl profile weakly depressed. Venter weakly concave, umbilical margin usually narrowly rounded, umbilical wall flat and steep. Adult ornament with extremely fine growth lines. Septa without inflexions, slightly concave. Suture line simple with shallow external lobe and broadly rounded lateral lobe.

Etymology

Combination of the name of the type region and *Nautilus*.

Included species

NW Iran (this paper): *Julfanautilus ashourii* gen. et sp. nov., Wuchiapingian; *Julfanautilus hairapetiani* gen. et sp. nov., Wuchiapingian.

Remarks

Julfanautilus gen. nov. has some similarities to *Coelogasteroceras*, particularly in the pachyconic conch and the shape of the venter with the shallow median groove. However, the specimens of *Coelogasteroceras* have a rounded umbilical margin, which differs from the angulate or subangular umbilical margin in *Julfanautilus*. Since the shape of the umbilical margin is very stable in numerous Carboniferous and Permian nautiloids, this is also assumed for *Julfanautilus*. The similarity in venter shape between *Coelogasteroceras* and *Julfanautilus* is therefore interpreted as a case of convergent morphological evolution.

Julfanautilus ashourii gen. et sp. nov.

urn:lsid:zoobank.org:act:B2ABF480-DEB4-43BA-97D1-80FFF3C2B11B

Fig. 49; Table 29

New genus H, new species – Korn 2025: 70, fig. 35.

Diagnosis

Species of *Julfanautilus* gen. nov. with a thinly pachyconic, subinvolute conch ($ww/dm \sim 0.65$; $uw/dm \sim 0.25$), weakly depressed whorl profile ($ww/wh \sim 1.30$) and extraordinarily high coiling rate (WER ~ 3.10) at a conch diameter of 80 mm. Whorl profile with a weakly concave venter, a subangular

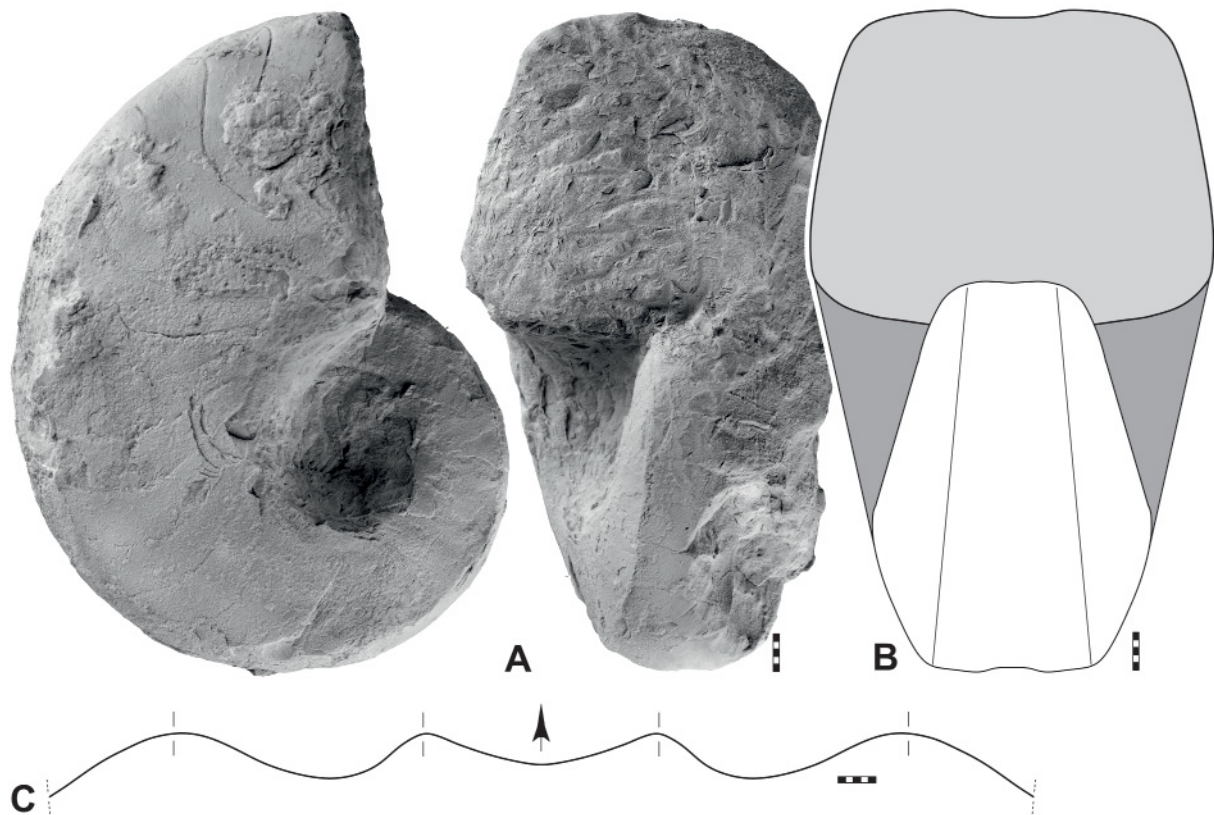

Fig. 49. *Julfanautilus ashourii* gen. et sp. nov., holotype MB.C.32095 (Korn *et al.* 2011 Coll.) from the *Vedioceras* Beds of the Julfa Formation at Aras Valley. **A.** Lateral and apertural views. **B.** Reconstruction of apertural view. **C.** Suture line at $dm=76$ mm, $ww=55$ mm, $wh=42$ mm. Scale bar units = 1 mm.

Table 29. Conch dimensions (in mm) and ratios of the holotype of *Julfanautilus ashourii* gen. et sp. nov.

| Nr. | dm | ww | wh | uw | ah | ww/dm | ww/wh | uw/dm | WER | IZR |
|------------|------|------|------|------|------|-------|-------|-------|------|------|
| MB.C.32095 | 87.4 | 54.4 | 42.2 | 21.0 | 37.8 | 0.62 | 1.29 | 0.24 | 3.10 | 0.10 |

ventrolateral shoulder, flatly convex and weakly convergent flanks, a narrowly rounded umbilical margin, a steep and flattened umbilical wall and a small imprint zone (IZR ~0.10). Suture line with a broadly rounded and shallow external lobe and a broadly rounded lateral lobe.

Etymology

Named after Ali Reza Ashouri (Mashhad), to acknowledge his support in the project.

Type material

Holotype

IRAN – **West Azerbaijan** • Aras Valley; *Vedioceras* Beds of the Julfa Formation (late Wuchiapingian); 2011; Korn *et al.* leg.; illustrated in Fig. 49; MB.C.32095.

Description

Holotype MB.C.32095 is a fully chambered conch with a diameter of 87 mm (Fig. 49A); suggesting a total diameter of approximately 150 mm including the body chamber. It is thinly pachyconic ($ww/dm=0.62$) and subinvolute ($uw/dm=0.24$) with an extraordinarily high coiling rate ($WER=3.10$). There is almost no whorl overlap. The whorls are widest at the pronounced, narrowly rounded umbilical margin; the umbilical wall is steep and flattened. The flanks converge towards the pronounced ventrolateral shoulder, which separates them from the broad and weakly flattened venter. The midventer possesses a very shallow longitudinal depression. Shell remains are not preserved. The suture line has a shallow, broadly rounded external lobe and a broad and shallow lateral lobe of equal depth (Fig. 49C).

Remarks

Julfanautilus ashourii gen. et sp. nov. differs from *J. hairapetiani* gen. et sp. nov. in the open umbilicus, which is closed in *J. hairapetiani* and in the higher coiling rate ($WER \sim 3.10$ in *J. ashourii* but only ~ 2.60 in *J. hairapetiani*).

Julfanautilus hairapetiani gen. et sp. nov.

urn:lsid:zoobank.org:act:AF3620C5-D1F3-401D-8B29-8BB929B610E2

Fig. 50; Table 30

Diagnosis

Species of *Julfanautilus* gen. nov. with a thinly pachyconic, involute conch ($ww/dm \sim 0.65$; $uw/dm \sim 0.05$), weakly depressed whorl profile ($ww/wh \sim 1.15$) and extremely high coiling rate ($WER \sim 2.60$) at a conch diameter of 80 mm. Whorl profile with a weakly concave venter, a pronounced ventrolateral shoulder, flatly convex and moderately convergent flanks, a narrowly rounded umbilical margin, a steep and flattened umbilical wall and a moderately deep imprint zone (IZR ~0.30). Suture line with broadly rounded and shallow external lobe and broadly rounded lateral lobe.

Etymology

Named after Vachik Hairapetian (Isfahan), to acknowledge his support in the research project on the Permian–Triassic boundary.

Type material

Holotype

IRAN – **East Azerbaijan** • Ali Bashi 4; *Vedioceras* Beds of the Julfa Formation (late Wuchiapingian); 2010; Korn *et al.* leg.; illustrated in Fig. 50; MB.C.32096.

Table 30. Conch dimensions (in mm) and ratios of the holotype of *Julfanautilus hairapetiani* gen. et sp. nov.

| Nr. | dm | ww | wh | uw | ah | ww/dm | ww/wh | uw/dm | WER | IZR |
|------------|------|------|------|-----|------|-------|-------|-------|------|------|
| MB.C.32096 | 83.2 | 52.2 | 45.2 | 2.5 | 31.4 | 0.63 | 1.15 | 0.03 | 2.58 | 0.31 |

Description

Holotype MB.C.32096 has a conch diameter of 83 mm and is fully chambered (Fig. 50A). It is thinly pachyconic ($ww/dm=0.63$) with an almost closed umbilicus and an extremely high coiling rate ($WER=2.58$). The whorl profile shows that the preceding whorl is strongly embraced ($IZR=0.31$). The conch is widest at the pronounced, narrowly rounded umbilical margin, from where a steep, broadly rounded umbilical wall approaches the umbilical seam. The flanks converge towards the broadly rounded ventrolateral shoulders; the venter is broadly rounded with a shallow and wide median depression. Shell remains are not preserved. The suture line has a shallow, broadly rounded external lobe and a much larger and broadly rounded lateral lobe, which is twice as deep as the external lobe (Fig. 50C).

Remarks

Julfanautilus hairapetiani gen. et sp. nov. differs from *J. ashourii* gen. et sp. nov. in the closed umbilicus ($uw/dm=0.24$ in *J. ashourii*) and the lower coiling rate ($WER \sim 2.60$ in *J. hairapetiani* but ~ 3.10 in *J. ashourii*).

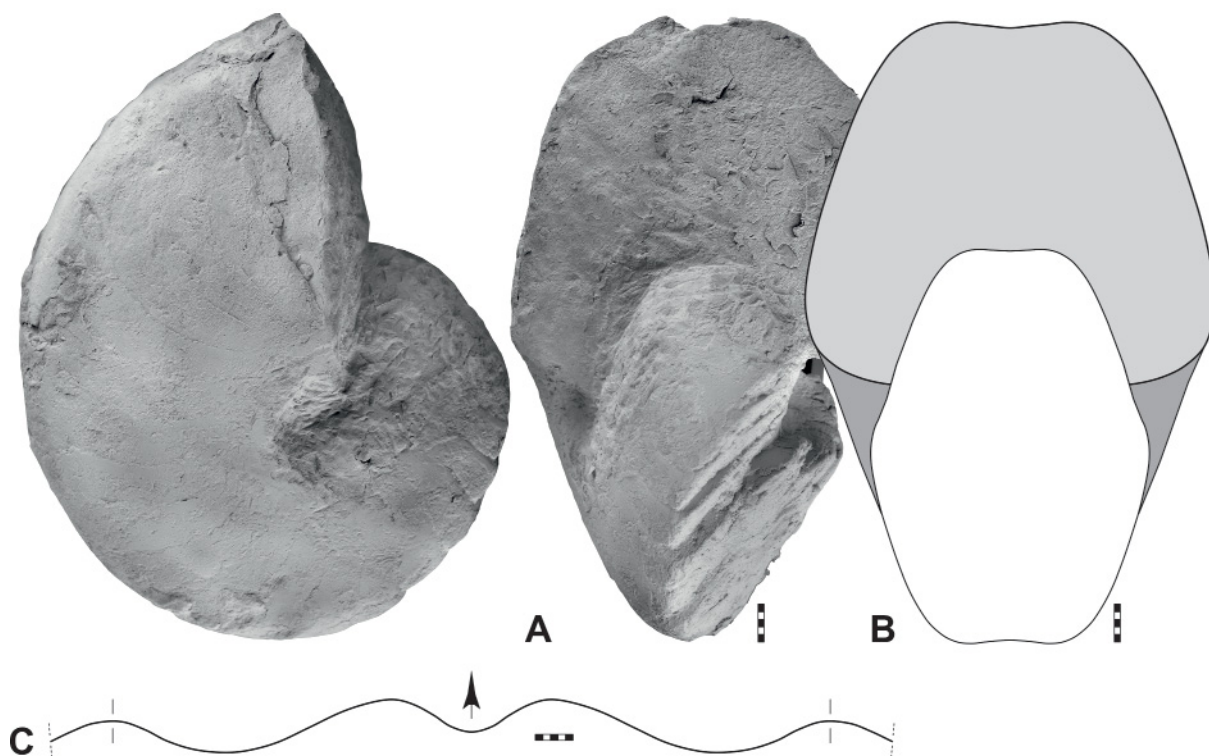

Fig. 50. *Julfanautilus hairapetiani* gen. et sp. nov., holotype MB.C.32096 (Korn *et al.* 2010 Coll.) from the *Vedioceras* Beds of the Julfa Formation at Ali Bashi 4. **A.** Lateral and apertural views. **B.** Reconstruction of apertural view. **C.** Suture line at $dm=70.5$ mm, $ww=52.5$ mm, $wh=44.5$ mm. Scale bar units=1 mm.

New genus F Korn & Hairapetian (in press)

Type species

New species R to be described by Korn & Hairapetian (in press); original designation.

Diagnosis

Genus of the family Julfanautilidae fam. nov. with discoidal, involute conch. The conch is rapidly increasing in height with a very high to extremely high coiling rate (WER usually higher than 2.50). Whorls moderately strongly embracing, their profile ranges from compressed to weakly depressed. Adult ornament with extremely fine growth lines. Septa without inflexions, slightly concave. Suture line simple, nearly straight to straight with a low external saddle, broadly rounded internal lobe. The siphuncle has a dorsocentral position (from Korn & Hairapetian in press).

Included species

Central Iran (Korn & Hairapetian in press): new species R to be described by Korn & Hairapetian (in press), Wuchiapingian.

Remarks

Korn & Hairapetian (in press) compared the new genus with other similar genera; in terms of conch morphology, the new genus shows some similarities to the genera *Julfanautilus* gen. nov. and the new genus E to be described by Korn & Hairapetian (in press). This is particularly true for the shape of the whorl profile with slightly flattened, converging flanks and the slightly flattened umbilical wall. However, the other two genera show a much higher coiling rate (WER above 3.00) than the new genus (WER around 2.50) and a much more pronounced subangular to angular umbilical margin.

New genus F Korn & Hairapetian (in press) sp.

Fig. 51; Table 31

Material examined

IRAN – **West Azerbaijan** • 1 specimen; Aras Valley; *Paratirolites* Limestone of the Ali Bashi Formation (late Changhsingian); 2011; Korn *et al.* leg.; illustrated in Fig. 51; MB.C.32097.

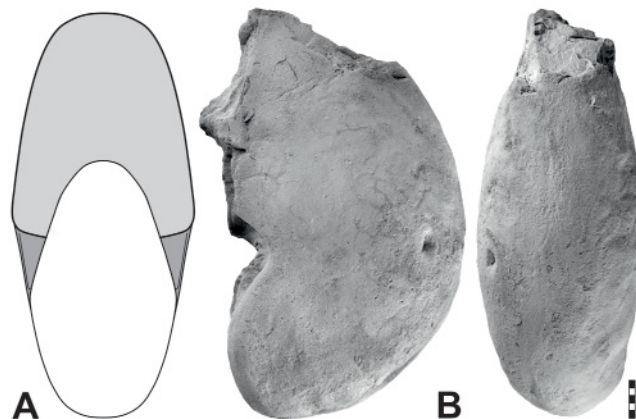

Fig. 51. New genus F Korn & Hairapetian (in press) sp., specimen MB.C.32097 (Korn *et al.* 2011 Coll.) from the *Paratirolites* Limestone of Ali Bashi. **A.** Reconstruction of apertural view. **B.** Lateral and ventral views. Scale bar units = 1 mm.

Table 31. Reconstructed conch dimensions (in mm) and ratios of the new genus F Korn & Hairapetian (in press) sp.

| Nr. | dm | ww | wh | uw | ah | ww/dm | ww/wh | uw/dm | WER | IZR |
|------------|----|----|----|----|----|-------|-------|-------|------|------|
| MB.C.32097 | 53 | 24 | 29 | 3 | 23 | 0.45 | 0.83 | 0.06 | 3.12 | 0.21 |

Description

Specimen MB.C.32097 is the fragment of a half whorl, which belongs entirely to the body chamber (Fig. 51A). The conch has a diameter of about 53 mm and is discoidal and involute ($ww/dm=0.45$; $uw/dm=0.06$). Flanks and venters are rounded. The surface of the internal mould appears to be completely smooth.

Remarks

The single specimen from the *Paratirolites* Limestone is too poorly preserved to be assigned to a specific species.

Suborder indet.

Genus and species indet.

Fig. 52

Material examined

IRAN – **East Azerbaijan** • 1 specimen; Ali Bashi 4; lower Julfa Formation (early Wuchiapingian); 2013; Korn *et al.* leg.; illustrated in Fig. 52; MB.C.32098.

Description

Specimen MB.C.32098 is the fragment of a quarter whorl, which belongs entirely to the phragmocone (Fig. 52A). The curvature of the whorl suggests that the conch was subinvolute. The whorl profile has a height of 24.5 mm and a width of 31.6 mm and is depressed elliptical without an umbilical margin or a ventrolateral venter; the whorl overlaps the preceding to a very low degree (Fig. 52B). The septa are arranged in short distances of less than 10 degrees. The suture line is nearly straight (Fig. 52C).

Remarks

The single specimen does not allow precise identification due to the fragmentary preservation and the small number of characteristic features. However, because of the unusual combination of characters, such as the weakly depressed elliptical whorl profile, the rather narrow umbilicus and especially the very dense septa, it is briefly described and illustrated here.

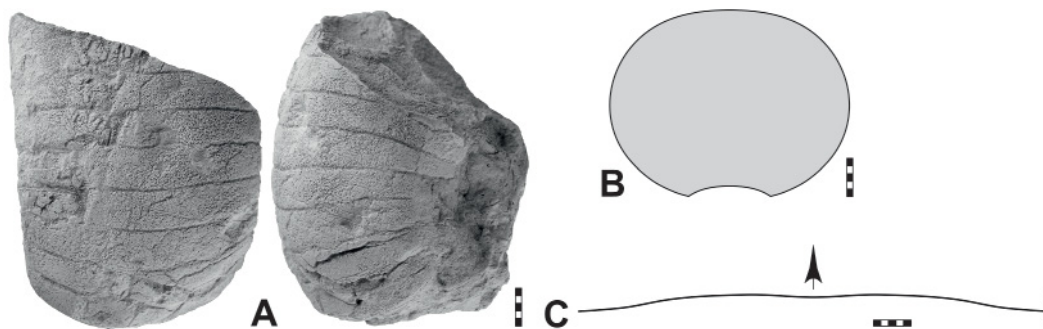

Fig. 52. gen. indet. sp., specimen MB.C.32098 (Korn *et al.* 2013 Coll.) from the *Araxoceras* Beds of the Julfa Formation at Ali Bashi 4. **A.** Reconstruction of apertural view. **B.** Lateral and ventral views. **C.** Suture line, at $wh = 24$ mm. Scale bar units = 1 mm.

Discussion

The Late Permian Julfa and Ali Bashi formations of sections near Julfa (NW Iran) have yielded diverse nautiloid assemblages. These species belong to 20 genera, eight of which are new: *Fididomaceras* gen. nov., *Azarinautilus* gen. nov., *Serometacoceras* gen. nov., *Alibashinautilus* gen. nov., *Tardunautilus* gen. nov., *Corotainoceras* gen. nov., *Celeroliroceras* gen. nov., *Julfanautilus* gen. nov. Based on new material, a total of 30 species is described, of which 24 are new. The material comes from four stratigraphic units, in ascending order:

Araxoceras Beds (early Wuchiapingian) – 19 species and one in open nomenclature: *Domatoceras elegantulum* sp. nov., *Domatoceras multituberculatum* sp. nov., *Domatoceras convergens* (Abich, 1878), *Permodomatoceras hamdii* sp. nov., *Fididomaceras gracile* (Shimansky, 1965) gen. et comb. nov., *Fididomaceras intracostatum* gen. et sp. nov., *Azarinautilus nahidae* gen. et sp. nov., *Aifinautilus hebes* sp. nov., *Serometacoceras dorsoarmatum* (Abich, 1878) gen. et comb. nov., *Serometacoceras dorashamense* (Shimansky, 1965) gen. et comb. nov., *Serometacoceras verae* (von Arthaber, 1900) gen. et comb. nov., *Serometacoceras cingulum* gen. et sp. nov., *Serometacoceras inflatum* gen. et sp. nov., *Alibashinautilus vetus* gen. et sp. nov., *Alibashinautilus* sp., *Tardunautilus minor* gen. et sp. nov., *Corotainoceras inerme* gen. et sp. nov., *Liroceras choopani* sp. nov., *Celeroliroceras celere* gen. et sp. nov., *Permonautilus abichi* (Kruglov, 1928).

Vedioceras Beds (late Wuchiapingian) – six species: *Serometacoceras parvituberculatum* gen. et sp. nov., *Tainoceras admonens* sp. nov., *Tainoceras latecostatum* sp. nov., *Peripetoceras parum* sp. nov., *Julfanautilus ashourii* gen. et sp. nov., *Julfanautilus hairapetiani* gen. et sp. nov.

Dzhulfites Beds (early Changhsingian) – three identified species and three in open nomenclature: *Tainoceras unitum* sp. nov., *Tirolonautilus* sp. 2, *Serometacoceras arasense* gen. et sp. nov., new genus C to be described by Korn & Hairapetian (in press) sp., *Tardunautilus nimius* gen. et sp. nov., new genus A to be described by Korn & Hairapetian (in press) sp.

Paratirolites Limestone (late Changhsingian) – two identified species and two in open nomenclature: *Alibashinautilus ambiguus* gen. et sp. nov., *Tainionutilus deinceps* sp. nov., *Tirolonautilus* sp. 1, *Baghuknautilus* sp.

With 30 species, the assemblage from the area around Julfa is one of the most diverse Late Permian occurrences of coiled nautiloids. With 25 Wuchiapingian species alone, it is the most species-rich assemblage for this interval.

The succession of nautiloids in the Julfa sections shows a significant decline in both the number of specimens and the number of species above the lower *Araxoceras* Beds. This decline is almost diametrically opposed to the abundance and diversity of ammonoids, which are particularly common and diverse in the *Paratirolites* Limestone (Korn *et al.* 2016). The decline of nautiloids is accompanied by a deepening of the habitat (Leda *et al.* 2014; Gliwa *et al.* 2020); the nautiloids in the lower *Araxoceras* Beds occur in association with species-rich brachiopod assemblages (Ghaderi *et al.* 2014).

A comparison of the nautiloids from Julfa with the assemblages from other regions with fossil-bearing Late Permian sedimentary rocks is difficult for several reasons. (1) A precise stratigraphic correlation is often difficult or impossible. (2) Facies differences between the various occurrences make it difficult to compare similar positions in the sedimentation basins and thus the habitats of the nautiloids. (3) Latitudinal differences and thus different seawater temperatures could have influenced the nautiloid associations.

Time-equivalent associations of nautiloids from central Iran (Korn & Hairapetian in press) show similar compositions at the family and genus level, but there are probably no common species from both regions. Although the two regions are separated by only about 1000 kilometres and have very similar sedimentary sequences (Leda *et al.* 2014; Gliwa *et al.* 2020; Korn *et al.* 2021; Heuer *et al.* 2022), there are clear differences in the nautiloid communities. The genus *Serometacoceras* gen. nov., which is well-represented in the Julfa sections, is very rare in the central Iranian sections, and the opposite is true for the new genera A and C to be described by Korn & Hairapetian (in press).

Acknowledgements

We are indebted to the Aras Free Zone Office (Julfa) for their support of the field sessions. We thank Lucyna Leda (Zamarte) and Nahideh Ghanizadeh Tabrizi (Tabriz) for assistance during the field work and for contributing numerous specimens, Markus Brinkmann (Berlin) for preparation of the specimens and Jenny Huang and Jamie Lembke (Berlin) for taking photographs. For access to the specimens in the Golfaraj Ecomuseum, we thank Eskandar Ebdali (Julfa). We acknowledge the reviews of an earlier version by Herwig Prinoth (St Ulrich) and an anonymous reviewer. We also acknowledge the careful editing by Kristiaan Hoedemakers and Natacha Beau.

Funding

Dieter Korn: Deutsche Forschungsgemeinschaft; DFG projects Ko1829/12-1, Ko1829/18-1 as well as the TERSANE research group FOR 2332.

Abbas Ghaderi: Ferdowsi University of Mashhad, grant 1/62381 and support by the Vice President for Research and Technology of the Ferdowsi University of Mashhad.

References

- Abich H. 1878. *Geologische Forschungen in den kaukasischen Ländern. Theil I. Eine Bergkalkfauna aus der Araxesenge bei Djoulfa in Armenien*. Hölder, Wien.
- Agassiz L. 1847. *An Introduction to the Study of Natural History: In a Series of Lectures Delivered in the Hall of the College of Physicians and Surgeons*. Greeley & McElrath, New York.
- Arakelyan R.A., Grunt T.A. & Shevyrev A.A. 1965. Kratkiy stratigraficheskiy ocherk. *Trudy paleontologicheskogo Instituta Akademiyi Nauk SSSR* 108: 20–25. [In Russian.]
- Barskov I.S., Leonova T.B. & Shilovsky O.P. 2014. Middle Permian cephalopods of the Volga-Ural Region. *Paleontological Journal* 48: 1331–1414. <https://doi.org/10.1134/S0031030114130012>
- Bisat W.S. 1930. On the goniatite and nautiloid fauna of the middle coal measures of England and Wales. *Summary of Progress of the Geological Survey of Great Britain* 1929: 75–89.
- Brühwiler T., Bucher H., Ware D., Schneebeli-Hermann E., Hochuli P.A., Roohi G., Ur-Rehman K. & Yaseen A. 2012. Smithian (Early Triassic) ammonoids from the Salt Range, Pakistan. *Special Papers in Palaeontology* 88: 5–114.
- Caneva G. 1906. La fauna del Calcare a *Bellerophon*. Contributo alla conoscenza dei limiti permotriassici. *Bollettino della Società Geologica italiana* 25: 427–452.
- Chao K.-K. 1940. Upper Paleozoic cephalopods from central Hunan, China. *Journal of Paleontology* 14 (1): 68–73.
- Chao K.-K. 1954. Permian cephalopods from Tanchiashan, Hunan. *Acta Palaeontologica Sinica* 2: 1–58.
- Chirat R., Vaslet D. & Le Nindre Y. 2006. Nautiloids of the Permian–Triassic Khuff Formation, central Saudi Arabia. *GeoArabia* 11: 81–92. <https://doi.org/10.2113/geoarabia110181>

- Dernov V. 2024. *Tainoceras luxaeterna* sp. nov., a new Late Pennsylvanian nautiloid species (Cephalopoda) from the Donets Basin, eastern Ukraine. *Historical Biology*: 1–6. <https://doi.org/10.1080/08912963.2024.2427080>
- Diener C. 1903. Himalayan fossils. Vol. I, Part 5. Permian fossils of the Central Himalayas. *Memoires of the Geological Survey of India. Palaeontologia Indica* 1: 1–204.
- Diener C. 1915. *Cephalopoda Triadica*. Junk, Berlin.
- Dzik J. 1984. Phylogeny of the Nautiloidea. *Palaeontologia Polonica* 45: 1–219.
- Ehiro M. & Araki H. 1997. Permian cephalopods of Kurosawa, Kesenuma City in the Southern Kitakami Massif, Northeast Japan. *Paleontological Research* 1: 55–66. <https://doi.org/10.2517/prpsj.1.55>
- Ehiro M. & Takizawa F. 1989. *Foordiceras* and *Domatoceras* (nautiloid cephalopods) from the Upper Permian Toyoma Formation, southern Kitakami Massif, Northeast Japan. *Transactions and proceedings of the Paleontological Society of Japan. New Series* 155: 212–217.
- Eichwald C.E. von 1857. Beitrag zur geographischen Verbreitung der fossilen Thiere Russlands. Alte Periode. Klasse der Cephalopoden. *Bulletin de la Société impériale des Naturalistes de Moscou* 30: 192–212.
- Flower R.H. & Kummel B. 1950. A classification of the Nautiloidea. *Journal of Paleontology* 24: 604–616.
- Foord A.H. 1891. *Catalogue of the Fossil Cephalopoda in the British Museum, Part II. Containing the Remainder of the Suborder Nautiloidea, Consisting of the Families Lituitidae, Trochoceratidae, and Nautilidae, with a Supplement*. Order of the Trustees, London.
- Frech F. 1905. *Lethaea geognostica 2, Das Mesozoicum, I. Trias*. Schweitzerbart, Stuttgart.
- Geinitz H.B. 1841. Über organische Reste im Zechstein bei Altenburg, Ronneburg und Gera. *Neues Jahrbuch für Mineralogie, Geognosie, Geologie und Petrefakten-Kunde* 1841: 637–642.
- Gemmellaro G.G. 1889. La Fauna dei Calcari con Fusulina della Valle del Fiume Sosio nella Provincia di Palermo, Fascicolo II. Nautiloidea, Gastropoda. *Giornale di Scienze naturali ed economiche* 20: 97–182. <https://doi.org/10.5962/bhl.title.10774>
- Ghaderi A., Garbelli C., Angiolini L., Ashouri A.R., Korn D., Rettori R. & Gharaie M.H.M. 2014. Faunal change near the end-Permian extinction: the brachiopods of the Ali Bashi Mountains, NW Iran. *Rivista Italiana di Paleontologia e Stratigrafia* 120: 27–59.
- Ghaderi A., Sadeghi A., Ashouri A.R. & Korn D. 2015. Study of Late Permian (Wuchiapingian) brachiopods of sedimentary succession at the Zal section, Northwest Iran. *Paleontology* 2: 219–229.
- Ghanizadeh Tabrizi N., Ghaderi A., Ashouri A.R. & Korn D. 2021. A new record of the Permian ammonoid family Cyclolobidae from Julfa (NW Iran). *Neues Jahrbuch für Geologie und Paläontologie, Abhandlungen* 302: 221–230. <https://doi.org/10.1127/njgpa/2021/1029>
- Girty G.H. 1911. On some new genera and species of Pennsylvanian fossils from the Wewoka formation of Oklahoma. *New York Academy of Science, Annals* 2: 119–156. <https://doi.org/10.1111/j.1749-6632.1911.tb56931.x>
- Gliwa J., Ghaderi A., Leda L., Schobben M., Tomás S., Foster W.J., Forel M.-B., Ghanizadeh Tabrizi N., Grasby S.E., Struck U., Ashouri A.R. & Korn D. 2020. Aras Valley (northwest Iran): high-resolution stratigraphy of a continuous central Tethyan Permian–Triassic boundary section. *Fossil Record* 23: 33–69. <https://doi.org/10.5194/fr-23-33-2020>

- Gliwa J., Forel M.-B., Crasquin S., Ghaderi A. & Korn D. 2021. Ostracods from the end-Permian mass extinction in the Aras Valley section (north-west Iran). *Papers in Palaeontology* 7: 1003–1042. <https://doi.org/10.1002/spp2.1330>
- Gliwa J., Wiedenbeck M., Schobben M., Ullmann C.V., Kiessling W., Ghaderi A., Struck U. & Korn D. 2022. Gradual warming prior to the end-Permian mass extinction. *Palaeontology*: e12621. <https://doi.org/10.1111/pala.12621>
- Golovkinsky N.A. 1868. *O permskoi formatsii v tsentral'noi chasti Kamsko–Volzhskogo basseina (On the Permian Strata in the Central Part of the Kama–Volga Basin)*. Imperatorskaya Akademiya Nauk, St. Petersburg. [In Russian.]
- Gordon M. Jr. 1960. Some American Midcontinent Carboniferous cephalopods. *Journal of Paleontology* 34: 133–151.
- Gordon M. Jr. 1965. Carboniferous cephalopods of Arkansas. *Professional Papers, U.S. geological Survey* 460: 1–322. <https://doi.org/10.3133/pp460>
- Gurley W.F.E. 1883. *New Carboniferous Fossils, Bulletin 2*. W.F.E. Gurley, Danville.
- Haniel C.A. 1915. Die Cephalopoden der Dyas von Timor. In: Wanner J. (ed.) *Paläontologie von Timor nebst kleineren Beiträgen zur Paläontologie einiger anderer Inseln des ostindischen Archipels*: 1–153. Schweizerbart, Stuttgart.
- Hayasaka I. 1957. Two Permian nautiloids from Takakura-yama near Yotsukura-machi, Fukushima Prefecture (Abukuma Plateau region). *Science Reports of the Yokohama National University. Section II, Biological and Geological Sciences* 6: 21–30.
- Hayasaka I. 1962. Two species of *Tainoceras* from the Permian of the Kitakami Mountains. *Bulletin of the National Science Museum* 6: 137–143.
- Heuer F., Leda L., Moradi Salimi H., Gliwa J., Hairapetian V. & Korn D. 2022. The Permian–Triassic boundary section at Baghuk Mountain, Central Iran: carbonate microfacies and depositional environment. *Palaeobiodiversity and Palaeoenvironments* 102: 331–350. <https://doi.org/10.1007/s12549-021-00511-1>
- Hind W. 1910. On four new Carboniferous nautiloids and a goniatite new to Great Britain. *Proceedings of the Yorkshire Geological Society* 17: 97–109. <https://doi.org/10.1144/pygs.17.2.97>
- Hyatt A. 1883–1884. Genera of fossil cephalopods. *Proceedings of the Boston Society of Natural History* 22: 253–338.
- Hyatt A. 1891. Carboniferous cephalopods. *Annual Report of the Geological Survey of Texas* 2: 327–356.
- Hyatt A. 1893. Carboniferous cephalopods. Second paper. *Annual Report of the Geological Survey of Texas* 4: 327–356, 379–474.
- Hyatt A. 1894. Phylogeny of an acquired characteristic. *Proceedings of the American Philosophical Society* 32: 349–647. <https://doi.org/10.5962/bhl.title.59826>
- Hyatt A. 1900. Cephalopoda. In: Zittel K.A.von & Eastman C.R. (eds) *Text-book of Palaeontology, Volume I, 1st Edition*: 502–604. Macmillan, London, New York.
- Isaa A., Ghaderi A., Ashouri A.R. & Korn D. 2016. Late Permian – Early Triassic conodonts of the Zal section at the northwest of Iran. *Stratigraphy and Sedimentology Researches* 32: 55–74.
- Kayser E. 1883. Obercarbonische Fauna von Lo-ping. In: Richthofen F.v. (ed.) *China*: 160–208. Reimer, Berlin.
- Kiessling W., Schobben M., Ghaderi A., Hairapetian V., Leda L. & Korn D. 2018. Pre–mass extinction decline of latest Permian ammonoids. *Geology* 46: 283–286. <https://doi.org/10.1130/G39866.1>

- King W. 1850. *A Monograph of the Permian Fossils of England*. Monographs of the Palaeontographical Society 3. The Palaeontographical Society, London. <https://doi.org/10.1080/02693445.1850.12088363>
- Klug C., Korn D., Landman N.H., Tanabe K., De Baets K. & Naglik C. 2015. Describing ammonoid conchs. In: Klug C., Korn D., De Baets K., Kruta I. & Mapes R.H. (eds) *Ammonoid Paleobiology: From Macroevolution to Paleogeography, Topics in Geobiology 44*: 3–24. Springer, Dordrecht. https://doi.org/10.1007/978-94-017-9630-9_1
- Korn D. 2010. A key for the description of Palaeozoic ammonoids. *Fossil Record* 13: 5–12. <https://doi.org/10.1002/mmng.200900008>
- Korn D. 2025. A revised classification of the Carboniferous and Permian Nautilida. *European Journal of Taxonomy* 1017: 1–85. <https://doi.org/10.5852/ejt.2025.1017.3065>
- Korn D. & Ghaderi A. 2019. The Late Permian araxoceratid ammonoids: a case of repetitive temporal and spatial unfolding of homoplastic conch characters. *Neues Jahrbuch für Geologie und Paläontologie, Abhandlungen* 292: 339–350. <https://doi.org/10.1127/njgpa/2019/0826>
- Korn D. & Hairapetian V. 2025. Late Permian nautiloids from Baghuk Mountain. *European Journal of Taxonomy* 1019: 1–76. <https://doi.org/10.5852/ejt.2025.1019.3071>
- Korn D. & Klug C. 2023. Early Carboniferous coiled nautiloids from the Anti-Atlas (Morocco). *European Journal of Taxonomy* 885: 156–194. <https://doi.org/10.5852/ejt.2023.885.2199>
- Korn D., Ghaderi A., Leda L., Schobben M. & Ashouri A.R. 2016. The ammonoids from the Late Permian *Paratirolites* Limestone of Julfa (East Azerbaijan, Iran). *Journal of Systematic Palaeontology* 14: 841–890. <https://doi.org/10.1080/14772019.2015.1119211>
- Korn D., Ghaderi A. & Ghanizadeh Tabrizi N. 2019. Early Changhsingian (Late Permian) ammonoids from NW Iran. *Neues Jahrbuch für Geologie und Paläontologie, Abhandlungen* 293: 37–56. <https://doi.org/10.1127/njgpa/2019/0829>
- Korn D., Leda L., Heuer F., Moradi Salimi H., Farshid E., Akbari A., Schobben M., Ghaderi A., Struck U., Gliwa J., Ware D. & Hairapetian V. 2021. Baghuk Mountain (Central Iran): high-resolution stratigraphy of a continuous Central Tethyan Permian–Triassic boundary section. *Fossil Record* 24: 171–192. <https://doi.org/10.5194/fr-24-171-2021>
- Kotlyar G.V., Zakharov Y.D., Koczyrkevicz B.V., Kropatcheva G.S., Rostovcev L.O., Chedija I.O., Vuks G.P. & Guseva E.A. 1983. Pozdnepermiskiy etap evolyutsii organicheskogo mira. Dzhulficheskiy i dorashamskiy yarusy SSSR. In: Gramm M.N. & Rostovcev L.O. (eds) *Proekt No 106 ("Permo-Triasovaya Stadiya geologicheskoy Evolyutsii") Mezhdunarodnoy Programmy geologicheskoy korrelyatsii*. NAUKA, Leningrad.
- Kotlyar G.V., Zakharov Y.D., Kropatcheva G.S., Pronina G.P., Chedija I.O. & Burago V.I. 1989. *Pozdnepermiskii Etap evolyutsii organicheskogo Mira. Midiinskii yarus SSSR*. Nauka, Leningrad. [In Russian.]
- Kruglov M.V. 1928. Verkhne-kamennougol'nye i artinskie nautilidy Urala. *Trudy geologicheskogo Muzeya Akademiya Nauk SSSR* 3: 63–206. [In Russian.]
- Kruglov M.V. 1933. Verkhnepermiskie nautilidy basseynov rek Pinegi i Kuloya [The Upper Permian Nautilida of the Pinega and Kuloi Rivers Basins]. *Trudy geologicheskogo Instituta Akademiya Nauk SSSR* 3: 185–208. [In Russian.]
- Kummel B. 1953. American Triassic coiled nautiloids. *Professional Papers, U.S. Geological Survey* 250: 1–104. <https://doi.org/10.3133/pp250>

- Kummel B. 1964. Nautiloidea-Nautilida. In: Moore R.C. (ed.) *Treatise on Invertebrate Paleontology*: K383–K466. The Geological Society of America and The University of Kansas Press, Lawrence, KS.
- Leda L., Korn D., Ghaderi A., Hairapetian V., Struck U. & Reimold W.U. 2014. Lithostratigraphy and carbonate microfacies across the Permian–Triassic boundary near Julfa (NW Iran) and in the Baghuk Mountains (Central Iran). *Facies* 60: 295–325. <https://doi.org/10.1007/s10347-013-0366-0>
- Leonova T.B. & Shchedukhin A.Y. 2020. Asselian-Sakmarian nautiloids of the Shakh-Tau Reef (Bashkortostan). *Paleontological Journal* 54: 1113–1134. <https://doi.org/10.1134/S0031030120100044>
- Liang X. 1984. Some nautiloids of Late Permian. *Acta Palaeontologica Sinica* 23: 699–704. [In Chinese.]
- Lintz J. 1958. The fauna of the Ames and Brush Creek shales of the Conemaugh Formation of western Maryland. *Journal of Paleontology* 32: 97–112.
- Ma J. 1997. Early Late Permian *Nautilus* in central Jiangxi. *Jiangxi Geology* 11: 27–32.
- McChesney J.H. 1860. Descriptions of new species of fossils from the Paleozoic rocks of the western states. *Transactions of the Chicago Academy of Science* 1: 1–76.
- Meek F.B. & Worthen A.H. 1865. Contributions to the palaeontology of Illinois and other Western States. *Proceedings of the Academy of Natural Sciences of Philadelphia* 17: 245–273.
- Merla G. 1930. La fauna del Calcare a *Bellerophon* della regione dolomitica. *Memorie dell'Istituto Geologico della Regia Università di Padova* 9: 1–221.
- Miao L., Dai X., Korn D., Brayard A., Chen J., Liu X. & Song H. 2021. A Changhsingian (Late Permian) nautiloid assemblage from Gujiao, South China. *Papers in Palaeontology* 7: 329–351. <https://doi.org/10.1002/spp2.1275>
- Miller A.K., Dunbar C.O. & Condra G.E. 1933. The nautiloid cephalopods of the Pennsylvanian system in the Mid-Continent region. *Nebraska Geological Survey Bulletin* 9: 1–240.
- Miller S.A. & Gurley W.F.E. 1897. New species of crinoids, cephalopods and other Palaeozoic fossils. *Bulletin of the Illinois State Museum of Natural History* 12.
- Miller A.K. & Kemp A.H. 1947. A *Koninckioceras* from the Lower Permian of north-central Texas. *Journal of Paleontology* 21: 351–354.
- Miller A.K. & Owen J.B. 1934. Cherokee nautiloids of the northern Mid-Continent region. *University of Iowa Studies in Natural History* 16: 185–272.
- Miller A.K. & Thomas H.D. 1936. The Casper Formation (Pennsylvanian) of Wyoming and its cephalopod fauna. *Journal of Paleontology* 10: 715–738.
- Miller A.K. & Unklesbay A.G. 1942a. Permian nautiloids from western United States. *Journal of Paleontology* 16: 719–738.
- Miller A.K. & Unklesbay A.G. 1942b. Permian nautiloids from western United States. *Journal of Paleontology* 16: 719–738.
- Miller A.K. & Youngquist W.L. 1949. American Permian nautiloids. *Geological Society of America Memoires* 41: 1–28. <https://doi.org/10.1130/MEM41-p1>
- Mojsisovics E.v.M. 1869. Beiträge zur Kenntnis der Cephalopoden-Fauna des alpinen Muschelkalkes. *Jahrbuch Der kaiserlich-königlichen geologischen Reichsanstalt, Wien* 19: 567–594.
- Mojsisovics E.v.M. 1882. Die Cephalopoden der mediterranen Triasprovinz. *Abhandlungen der kaiserlichen und königlichen geologischen Reichsanstalt* 10: 1–322.

- Mojsisovics E.v.M. 1902. Das Gebirge um Hallstatt. Die Cephalopoden der Hallstätter Kalke. 1. Band. *Abhandlungen der kaiserlichen und königlichen geologischen Reichsanstalt* 6: 175–356.
- Newell N.D. 1936. Some Mid-Pennsylvanian invertebrates from Kansas and Oklahoma: III. Cephalopoda. *Journal of Paleontology* 1: 481–489.
- Niko S. & Mapes R.H. 2015. Early Carboniferous nautiloids from the Ruddell Shale Member in Arkansas, Midcontinent North America. *Paleontological Research* 19: 52–60. <https://doi.org/10.2517/2014PR029>
- Niko S. & Mapes R.H. 2016. Late Carboniferous coiled nautiloids from the Lost Branch Formation of Oklahoma, Midcontinent North America. *Paleontological Research* 20: 75–79. <https://doi.org/10.2517/2015PR020>
- Niko S. & Mapes R.H. 2017. Tainoceratid and liroceratid nautilids from the Upper Mississippian Imo Formation of Arkansas, Midcontinent North America. *Paleontological Research* 21: 178–182. <https://doi.org/10.2517/2016PR020>
- Niko S., Mapes R.H. & Seuss B. 2022. Virgilian (Late Pennsylvanian) coiled nautiloids from the Finis Shale Member of the Graham Formation in Texas, southern Midcontinent North America. *Bulletin of the Tohoku University Museum* 21: 1–19.
- Posenato R. & Prinoth H. 2004. Orizzonti a nautiloidi ea brachiopodi della Formazione a *Bellerophon* (Permiano Superiore) in Val Gardena (Dolomiti). *Geo.Alp* 1: 71–85.
- Prinoth H. & Posenato R. 2007. Late Permian nautiloids from the *Bellerophon* Formation of the Dolomites (Italy). *Palaeontographica Abteilung A* 282: 135–165. <https://doi.org/10.1127/pala/282/2007/135>
- Qin Z. 1986. New material of early Late Permian cephalopods in Fengcheng-Gaoan area, Jiangxi. *Acta Palaeontologica Sinica* 25: 272–283. [In Chinese.]
- Ramsbottom W.H.C. & Moore E.W.J. 1961. Coiled nautiloids from the Viséan of Ireland. *Geological Journal* 2: 630–644. <https://doi.org/10.1002/gj.3350020406>
- Reed F.R.C. 1931. New fossils from the *Productus* Limestones of the Salt Range, with notes on other species. *Memoirs of the Geological Survey of India, Palaeontologia Indica* 17: 1–56.
- Reed F.R.C. 1944. Brachiopoda and Mollusca from the *Productus* limestones of the Salt Range. *Palaeontologia Indica, new series* 23: 1–768.
- Ruan Y. & Zhou Z. 1987. Carboniferous cephalopods in Ningxia Hui Autonomous Region. *Namurian Strata and Fossils of Ningxia, China*: 55–177.
- Ruzhencev V.E. & Shimansky V.N. 1954. Nizhnepermiskie svernutye i sognutie nautiloidei yuzhnogo Urala. *Trudy paleontologicheskogo Instituta Akademiya Nauk SSSR* 50: 1–152. [In Russian.]
- Schmidt H. 1951. Nautiliden aus deutschem Unterkarbon. *Paläontologische Zeitschrift* 24: 23–57. <https://doi.org/10.1007/BF03044551>
- Schobben M., Joachimski M.M., Korn D., Leda L. & Korte C. 2014. Palaeotethys seawater temperature rise and an intensified hydrological cycle following the end-Permian mass extinction. *Gondwana Research* 26: 675–683. <https://doi.org/10.1016/j.gr.2013.07.019>
- Schobben M., Stebbins A., Ghaderi A., Strauss H., Korn D. & Korte C. 2015. Flourishing ocean drives the end-Permian marine mass extinction. *Proceedings of the National Academy of Sciences* 112: 10298–10303. <https://doi.org/10.1073/pnas.1503755112>
- Schréter Z. 1974. Die Nautiloiden aus dem oberen Perm des Bükkgebirges. In: Sidó M., Zálányi B. & Schréter Z. (eds) *Neue paläontologische Ergebnisse aus dem Oberpaläozoikum des Bükkgebirges*: 253–311. Akadémia Kiadó, Budapest.

- Shimansky V.N. 1962a. Nadotryad Nautiloidea. Nautiloidei. Obshchaya chast. *In: Orlov Y.A. (ed.) Osnovy Paleontologii, Mollyuski - Golovonogie 1: 33–72.* Akademiya Nauk SSSR, Moscow. [In Russian.]
- Shimansky V.N. 1962b. Nadotryad Nautiloidea. Nautiloidei. Sistemicheskaya chast. Otryad Nautilida. *In: Orlov Y.A. (ed.) Osnovy Paleontologii, Mollyuski - Golovonogie 1: 115–169.* Akademiya Nauk SSSR, Moscow. [In Russian.]
- Shimansky V.N. 1962c. O skul'ptirovannykh formakh v nadsemeystve Lirocerataceae. *Paleontologicheskii Zhurnal* 1962: 74–78. [In Russian.]
- Shimansky V.N. 1965a. Nautiloidei. *Trudy paleontologicheskogo Instituta Akademiya Nauk SSSR* 108: 40–47. [In Russian.]
- Shimansky V.N. 1965b. Podotryad Nautiloidea. *Trudy paleontologicheskogo Instituta Akademiya Nauk SSSR* 108: 157–165. [In Russian.]
- Shimansky V.N. 1967. Kamennougol'nie Nautilida. *Trudy paleontologicheskogo Instituta Akademiya Nauk SSSR* 115: 1–258. [In Russian.]
- Shimansky V.N. 1979a. Nautilida (izuchennost', stratigraficheskoe rasprostranenie, etapy razvitiya). *Trudy paleontologicheskogo Instituta Akademiya Nauk SSSR* 170: 1–67. [In Russian.]
- Shimansky V.N. 1979b. Novye nautiloidei verkhnego Paleozoya Zakavkas'ya. *Byulleten' Moskovskogo Obshchestva Ispytatelei Prirody. Otdel geologicheskii* 54: 54–61. [In Russian.]
- Shumard B.F. & Swallow G.C. 1858. Descriptions of new fossils from the Coal Measures of Missouri and Kansas. *Transactions of the St. Louis Academy of Science* 1: 198–227.
- Simić V. 1933. Gornji Perm u Zapadnoj Srbiji [Das Oberperm in Westserbien]. *Rasprave geološkog Instituta Kraljevine Jugoslavije (Mémoires du Service géologique du Royaume de Yougoslavie)* 1: 1–130. [In Serbo-Croatian.]
- Stache G. 1877. Beitrage zur Fauna der Bellerophonkalke Südtirols. *Jahrbuch der kaiserlichen und königlichen geologischen Reichsanstalt* 27: 271–318.
- Stoyanow A.A. 1910. On the character of the boundary of Palaeozoic and Mesozoic near Djulfa. *Zapiski imperatorskago St.-Peterburgskago mineralogicheskago Obschestva = Verhandlungen der Russisch-kaiserlichen mineralogischen Gesellschaft zu St. Petersburg, 2. Serie* 47: 61–135.
- Sturgeon M.T. & Miller A.K. 1948. Some additional cephalopods from the Pennsylvanian of Ohio. *Journal of Paleontology* 22: 75–80.
- Sturgeon M.T., Windle D.L., Mapes R.H. & Hoare R.D. 1982. New and revised taxa of Pennsylvanian cephalopods in Ohio and West Virginia. *Journal of Paleontology* 56: 1453–1479.
- Sturgeon M.T., Windle D.L., Mapes R.H. & Hoare R.D. 1997. Pennsylvanian Cephalopods of Ohio. Part 1. Nautiloid and Bactritoid Cephalopods. *Ohio Division of Geological Survey, Bulletin* 71: 1–191.
- Swallow G.C. 1860. Descriptions of new fossils from the Carboniferous and Devonian rocks of Missouri. *Transactions of the St. Louis Academy of Sciences* 1: 635–660.
- Taschenberg E.O.W. 1882. Die Mallophagen mit besonderer Berücksichtigung der von Dr. Meyer gesammelten Arten. *Nova Acta der kaiserlich Leopoldinisch-Carolinisch-Deutschen Akademie der Naturforscher* 44: 1–244. <https://doi.org/10.5962/bhl.title.82513>
- Teichert C. 1940. Contributions to nautiloid nomenclature. *Journal of Paleontology*: 590–597.
- Teichert C. 1964. Morphology of hard parts. *In: Moore R.C. (ed.) Treatise on Invertebrate Paleontology: K13–K53.* The Geological Society of America and The University of Kansas Press, Lawrence, KS.

- Teichert C. & Kummel B. 1973. Nautiloid cephalopods from the Julfa Beds, Upper Permian, Northwest Iran. *Bulletin of the Museum of Comparative Zoology, Harvard University* 144: 409–434.
- Teichert C., Kummel B. & Sweet W.C. 1973. Permian–Triassic strata, Kuh-e-Ali Bashi, Northwestern Iran. *Bulletin of the Museum of Comparative Zoology, Harvard University* 145 (8): 359–472.
- Tichy G. 1975. Über das Erstauftreten von *Permonautilus* aus der Foldvik Creek Formation (Oberperm) von Ostgrönland. *Neues Jahrbuch für Geologie und Paläontologie, Monatshefte* 1975: 693–703.
- Trenkner W. 1868. Palaeontologische Novitäten vom nordwestlichen Harze. I. Iberger Kalk und Kohlengebirge von Grund. *Abhandlungen der naturforschenden Gesellschaft zu Halle* 10: 123–182.
- Tucker J.K. 1976. A coiled nautiloid fauna from the Mattoon Formation (Pennsylvanian) of Illinois. *Transactions of the Illinois State Academy of Science* 69: 57–77.
- Tucker J.K. & Mapes R.H. 1978. Coiled nautiloid cephalopods from the Wolf Mountain Shale (Pennsylvanian), north-central Texas. *Journal of Paleontology* 52: 596–604.
- Tucker J.K., Mapes R.H. & Aronoff S.M. 1978. New coiled nautiloids from the Wewoka Formation (Pennsylvanian) of Oklahoma. *Journal of Paleontology* 52: 67–72.
- Turner J.S. 1954. New Carboniferous nautiloids from the North of England. *Transactions of Leeds Geologists Association* 6: 219–226.
- Tzwetaev M. 1888. Golovonogiya verkhnego yarusa srednerusskago kamenougol'nago izvestnyaka. *Trudy geologicheskogo Komiteta* 5: 1–58. [In Russian.]
- Tzwetaev M. 1898. Nautilidy i ammoni nizhnyago otdela Srednerusskago kamennougol'nago izvestnyaka. *Trudy geologicheskogo Komiteta* 8: 1–46. [In Russian.]
- Unklesbay A.G. 1962. Pennsylvanian Cephalopods of Oklahoma. *Bulletin of the Oklahoma Geological Survey* 96: 1–150.
- Vaillant-Couturier Treat I. 1933. Paléontologie de Madagascar. XIX. Le Permo-Trias marin. *Annales de Paléontologie* 22: 39–96.
- von Arthaber G. 1900. Das jüngere Paläozoicum aus der Araxes-Enge bei Djulfa. *Beiträge zur Paläontologie und Geologie Österreich-Ungarns und des Orients* 12: 209–302.
- Waagen W. 1879. Salt Range fossils, 1. *Productus* Limestone fossils. *Palaeontologia Indica* 1: 1–85.
- Worthen A.H. & Meek F.B. 1875. Descriptions and illustrations of invertebrate fossils from the Paleozoic formations. *Illinois Geological Survey* 6: 69–154.
- Wu S. & Kuang W. 1992. Study of nautiloids in the Upper Permian Changxingian reefs from Lichuan, west Hubei. *Journal of China University of Geosciences* 17: 289–294.
- Xu G. 1977. Cephalopoda, *Fossil Atlas of South-Central China, Part* 537–582. Geological Publishing House, Beijing.
- Yakovlev N. 1899. Fauna nekotorykh verkhnepaleozoyskikh otlozheniy Rossii. 1. Golovonogie i brakhiopody. *Trudy Geologicheskoy Komiteta* 15: 1–150. [In Russian.]
- Yang Z., Yin H., Wu S., Yang F., Ding M. & Xu G. 1987. Permian–Triassic boundary stratigraphy and fauna of South China. *Geological Memoirs* 2: 1–379.
- Zhao J., Liang X. & Zheng Z. 1978. Late Permian cephalopods from South China. *Palaeontologia Sinica, Series B* 12: 1–194. [In Chinese.]
- Zheng Z. 1984. Late Permian nautiloids from western Guizhou. *Acta Palaeontologica Sinica* 23: 239–253. [In Chinese.]

Printed versions of all papers are deposited in the libraries of four of the institutes that are members of the *EJT* consortium: Muséum national d'Histoire naturelle, Paris, France; Meise Botanic Garden, Belgium; Royal Museum for Central Africa, Tervuren, Belgium; Royal Belgian Institute of Natural Sciences, Brussels, Belgium. The other members of the consortium are: Natural History Museum of Denmark, Copenhagen, Denmark; Naturalis Biodiversity Center, Leiden, the Netherlands; Museo Nacional de Ciencias Naturales-CSIC, Madrid, Spain; Leibniz Institute for the Analysis of Biodiversity Change, Bonn – Hamburg, Germany; National Museum of the Czech Republic, Prague, Czech Republic; The Steinhardt Museum of Natural History, Tel Aviv, Israël.